

The Big Woods Triangle foundations

Angle 1

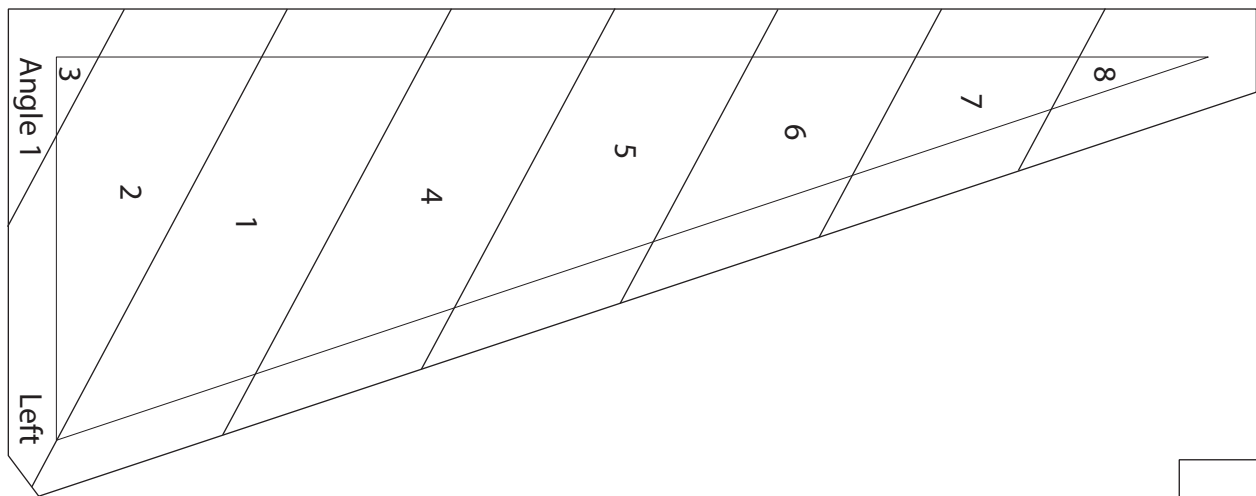
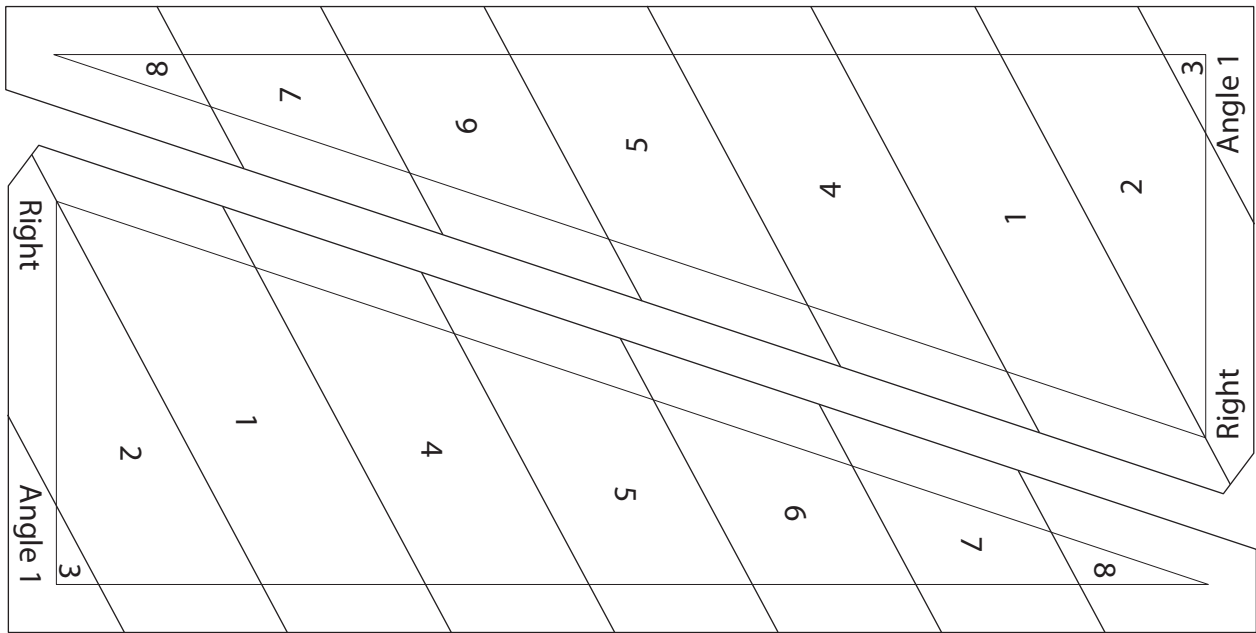
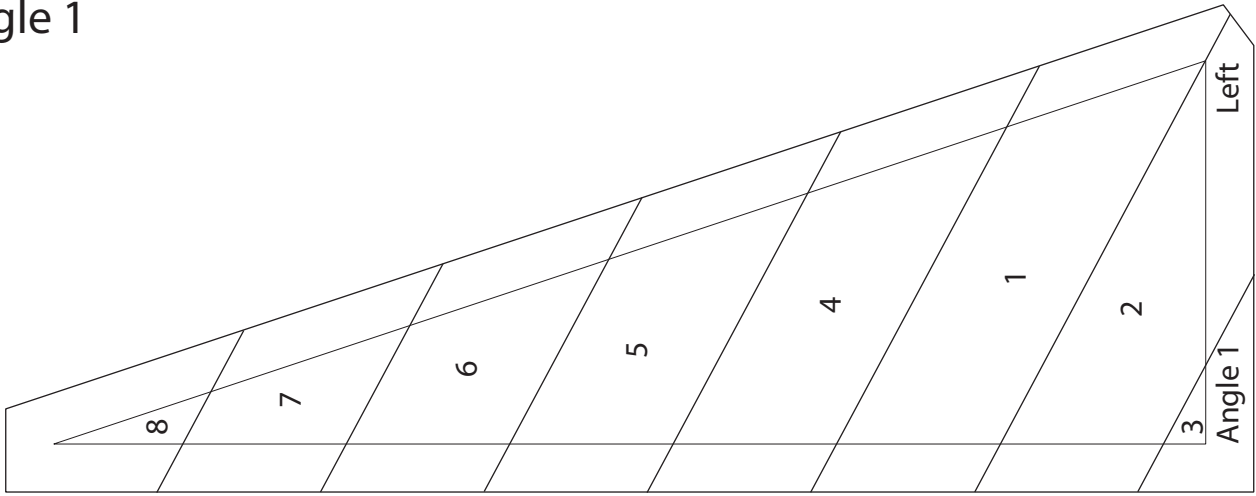

This box
should measure
1 inch square

The Big Woods Triangle foundations

Angle 2

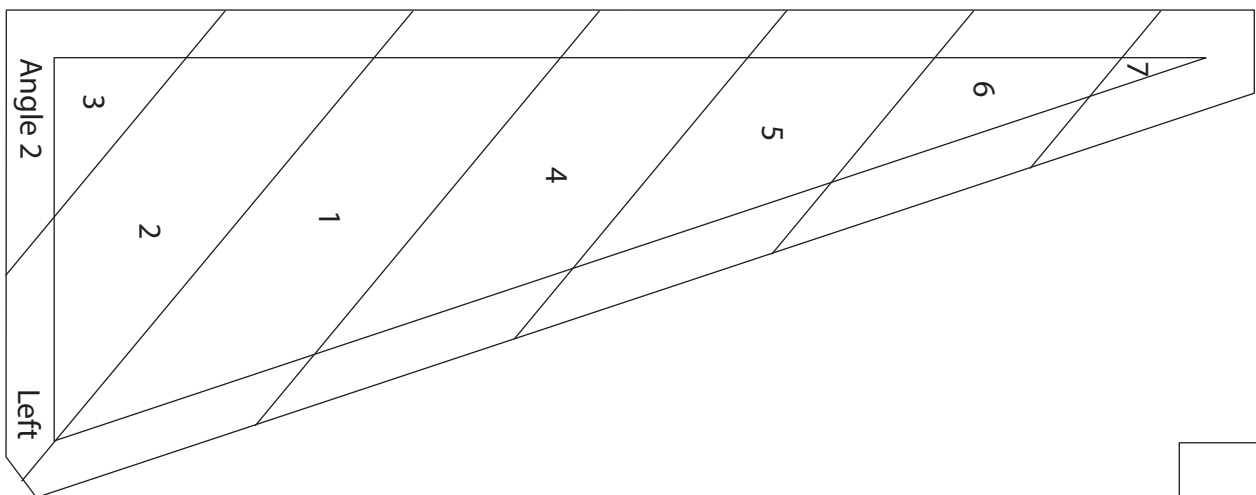
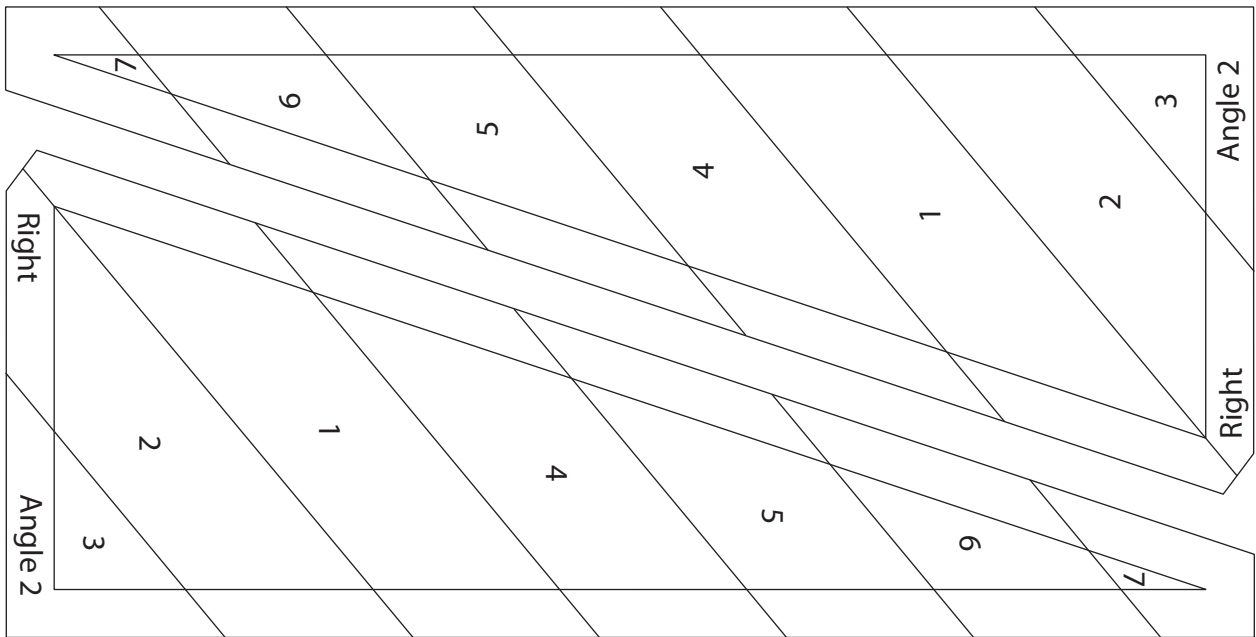
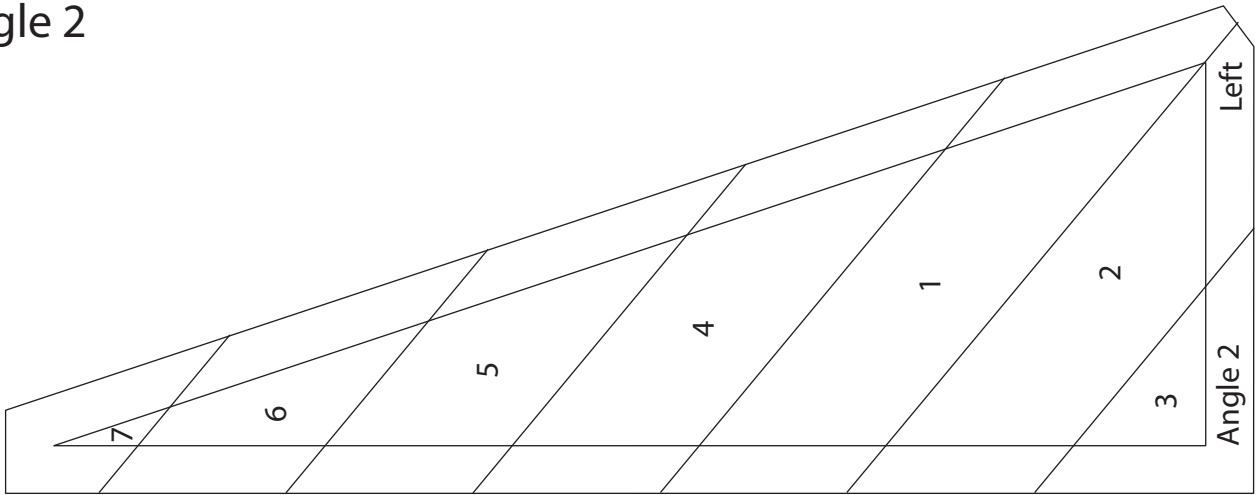

This box
should measure
1 inch square

The Big Woods Triangle foundations

Angle 3

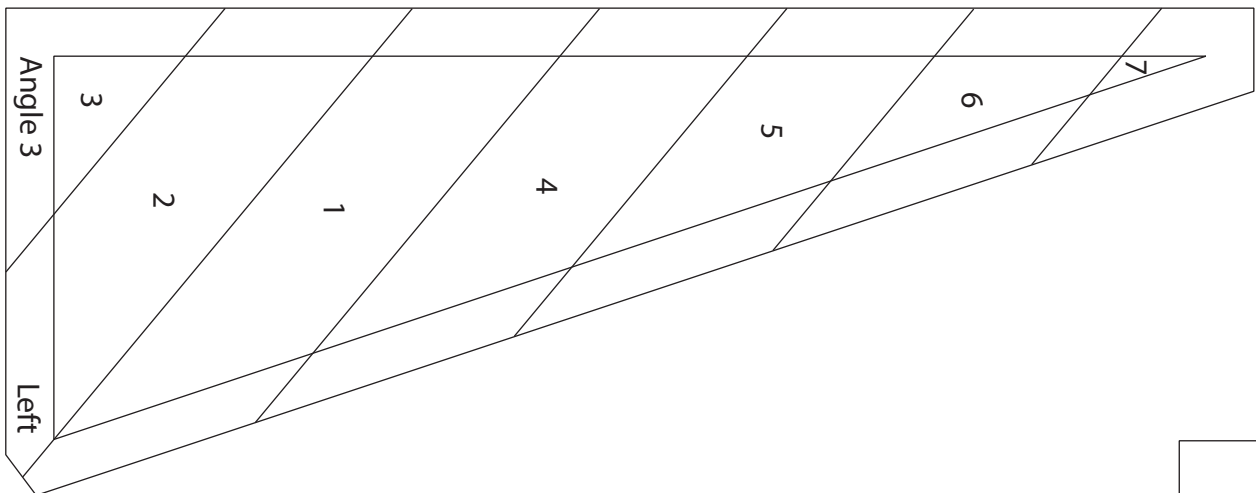
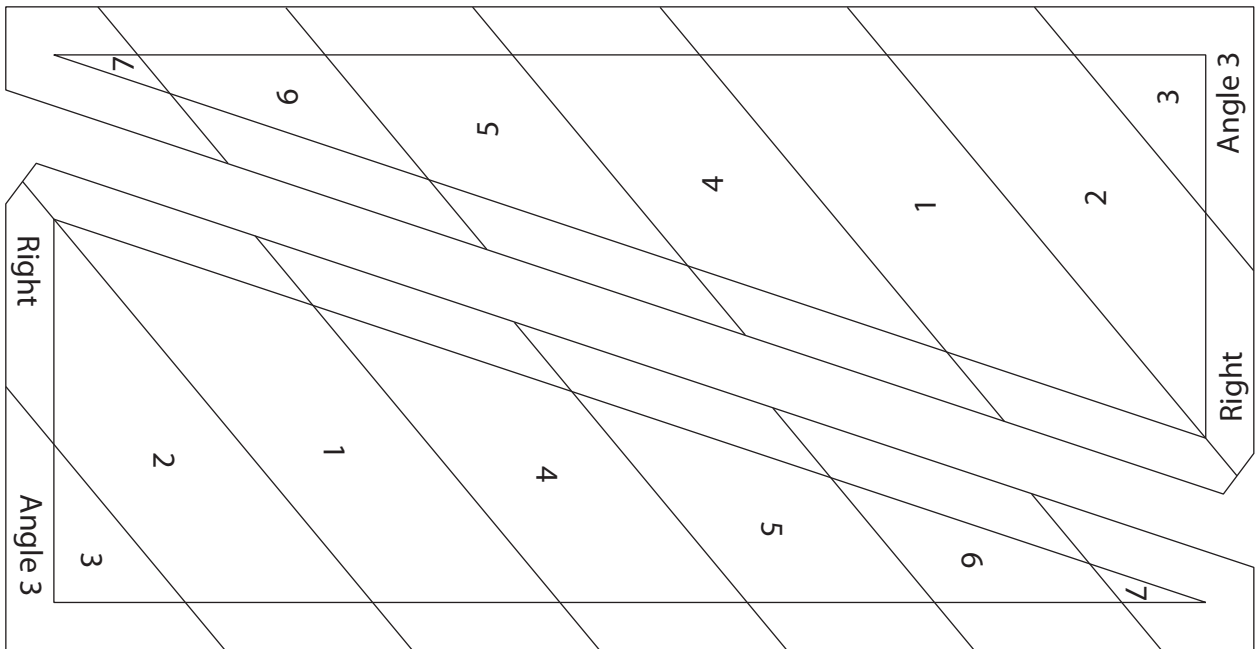
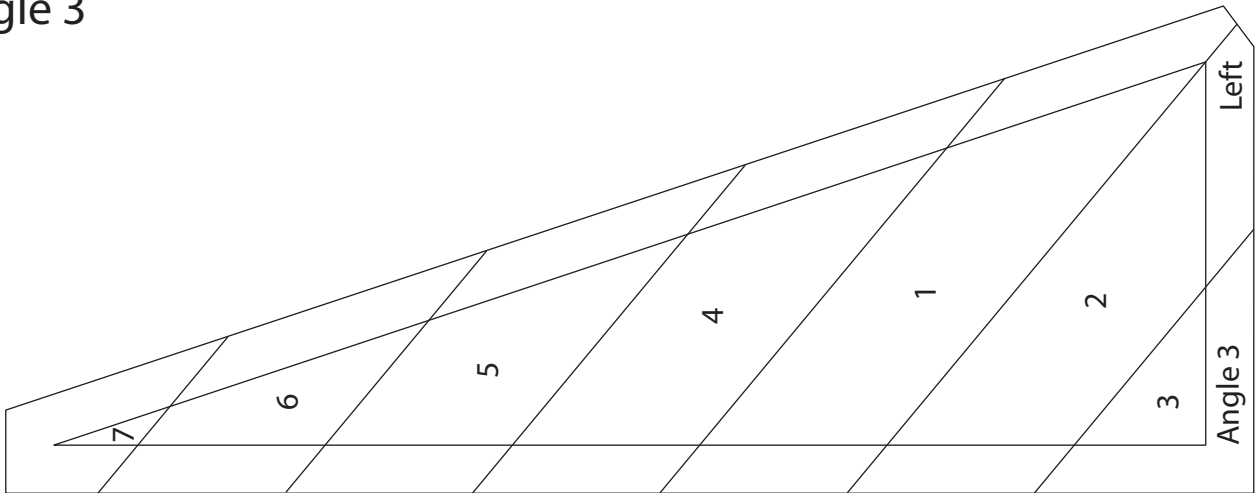

This box
should measure
1 inch square

The Big Woods Triangle foundations

Angle 4

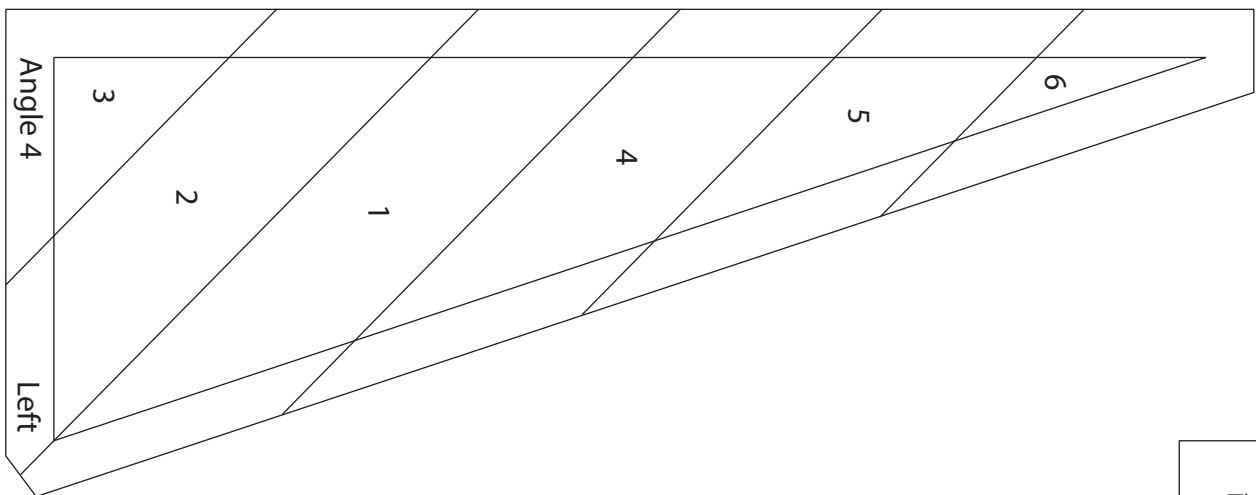
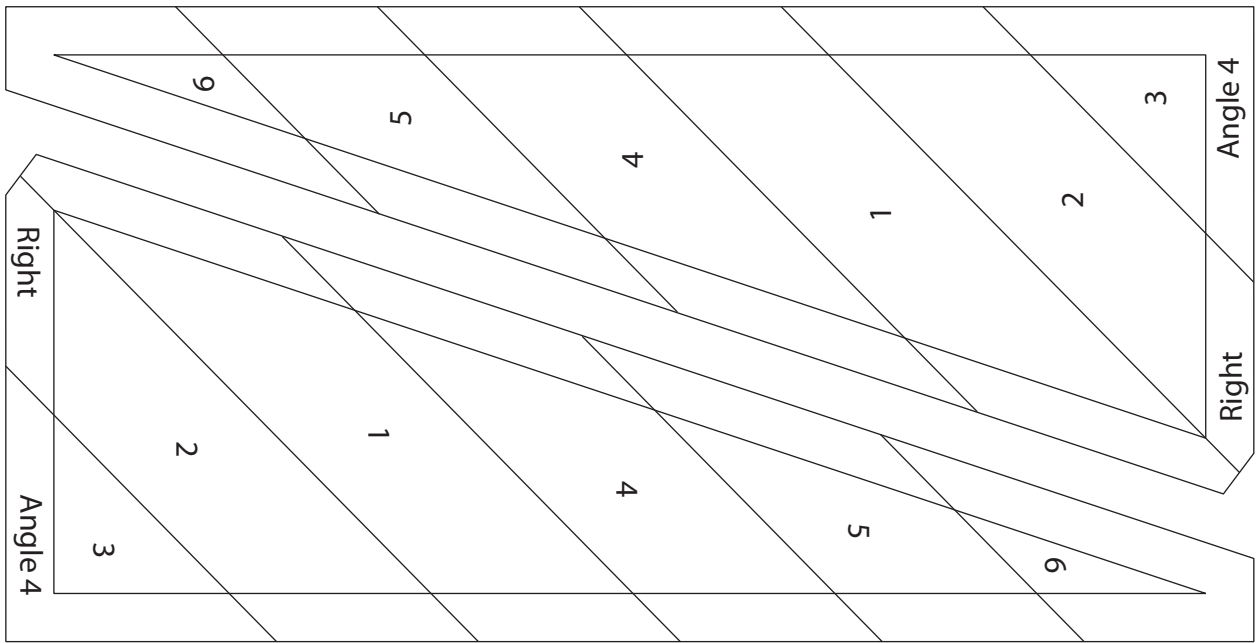
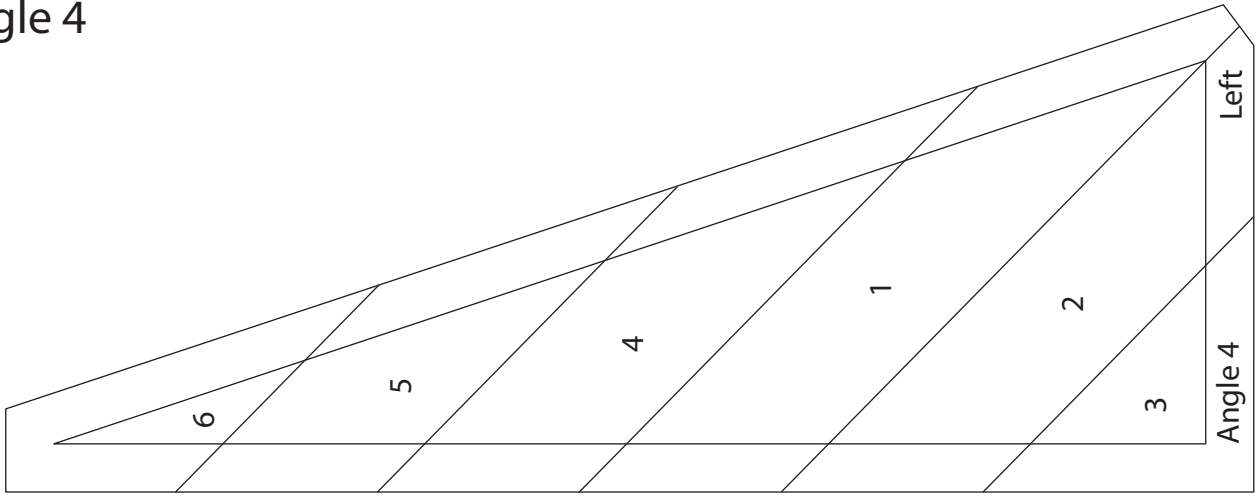

This box
should measure
1 inch square

The Big Woods Triangle foundations

Angle 5

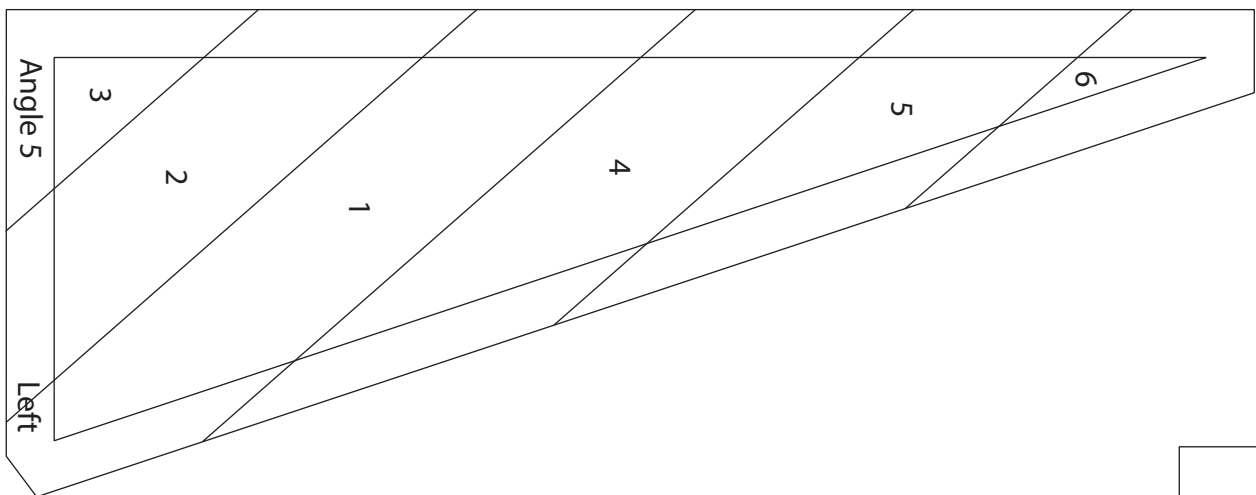
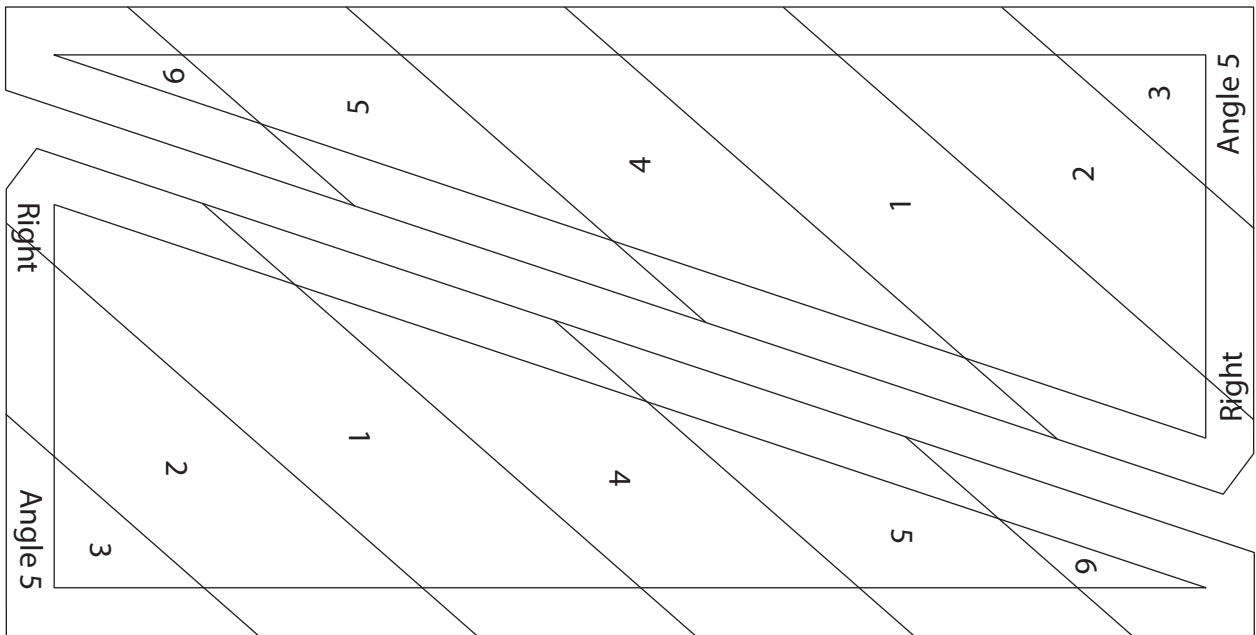
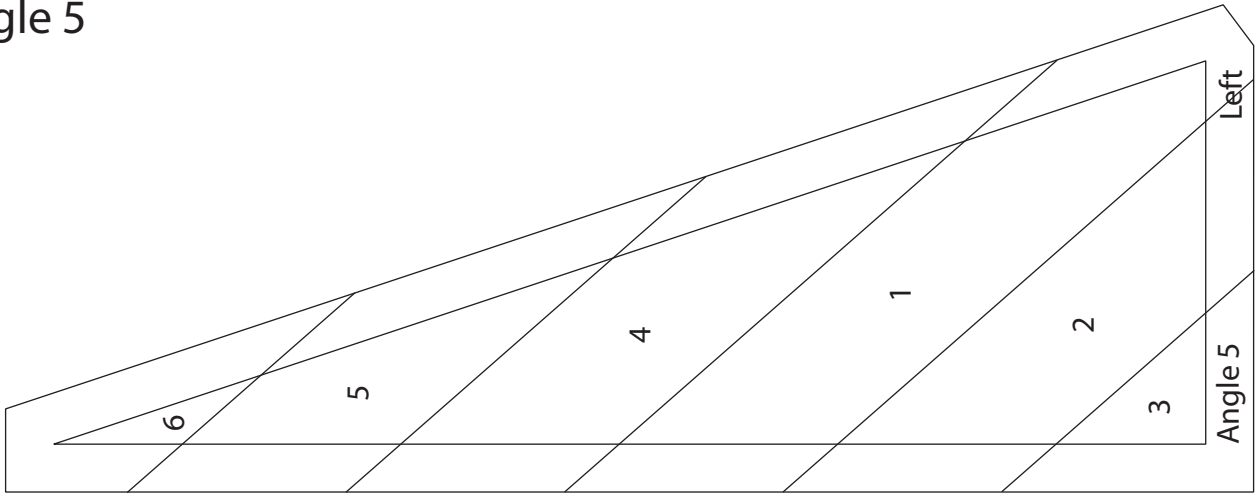

This box
should measure
1 inch square

The Big Woods Triangle foundations

Angle 6

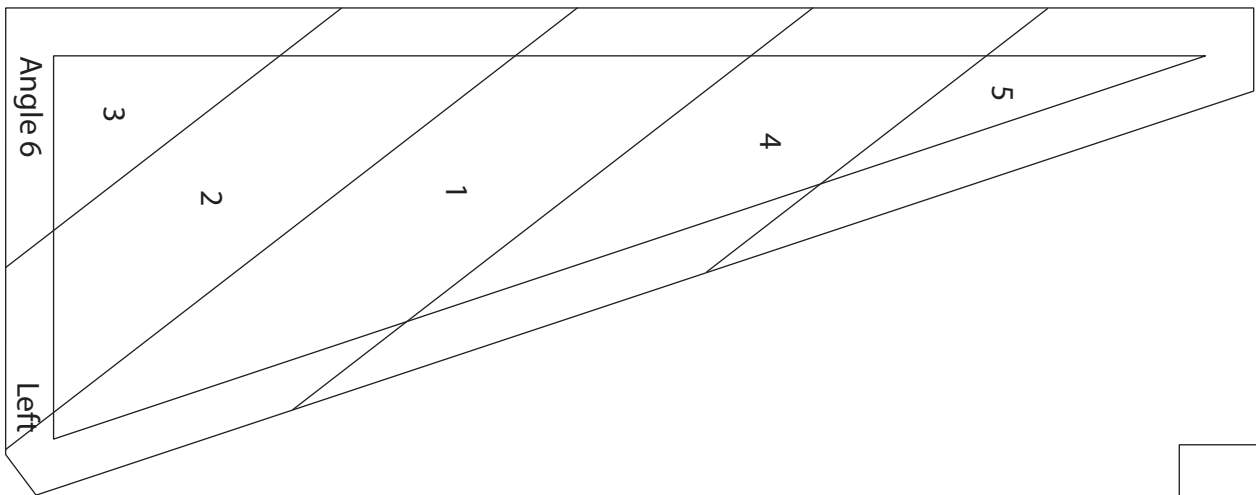
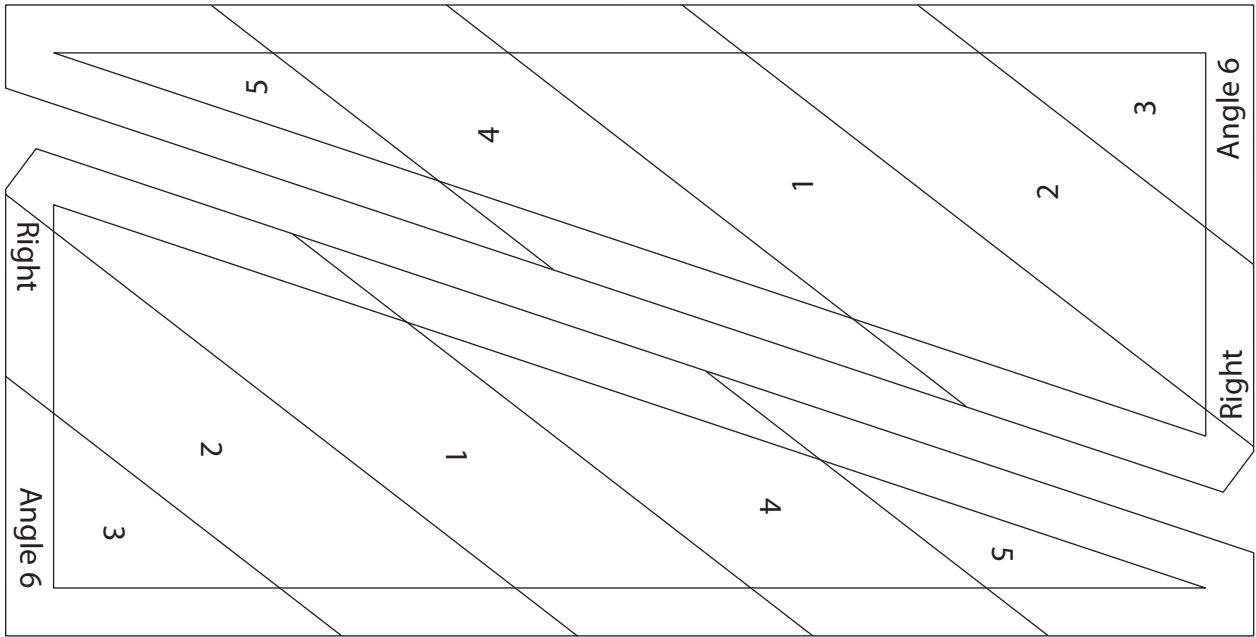
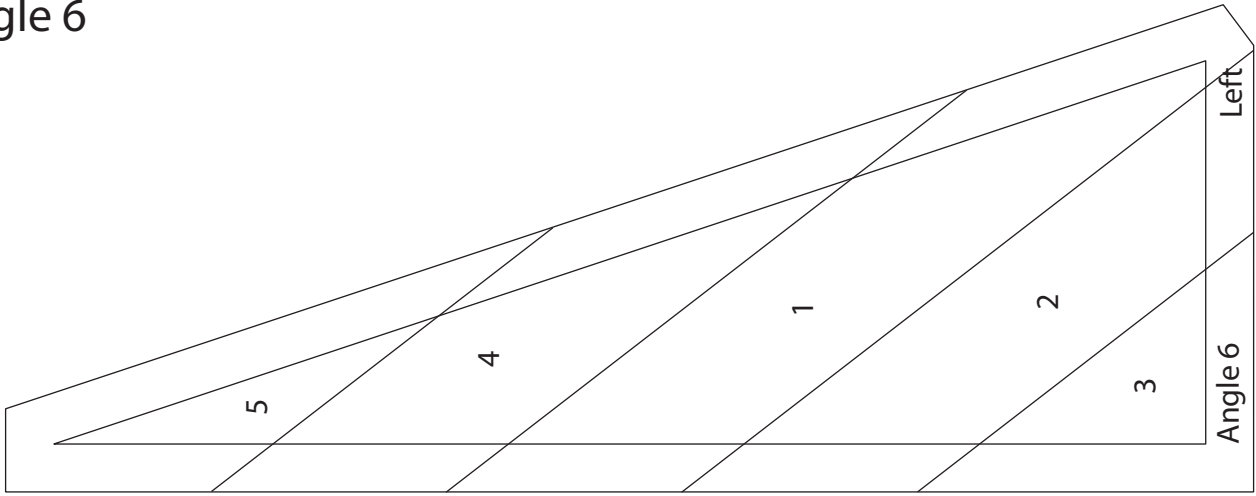

This box
should measure
1 inch square

The Big Woods Triangle foundations

Angle 7

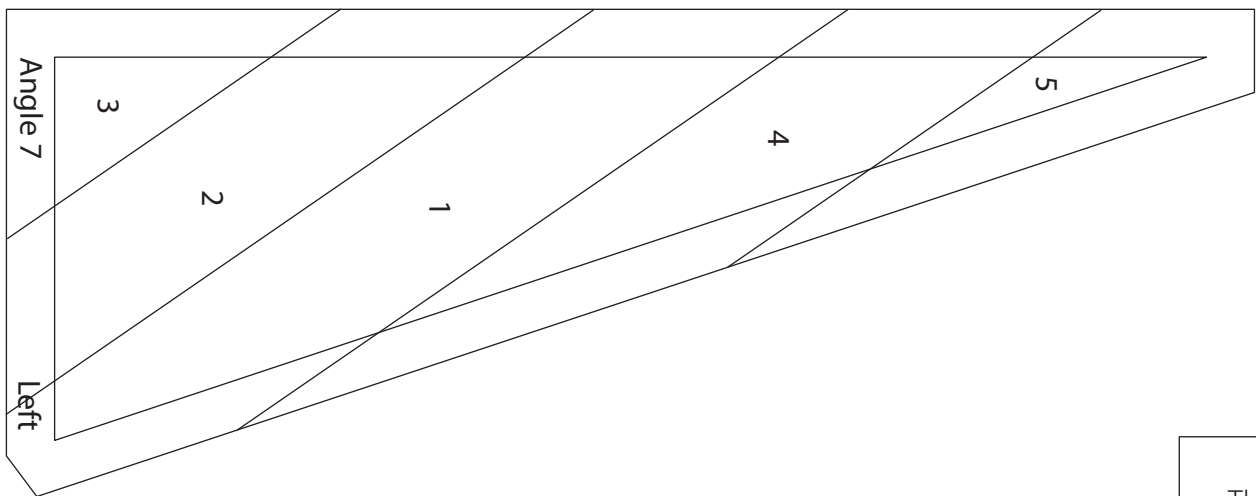
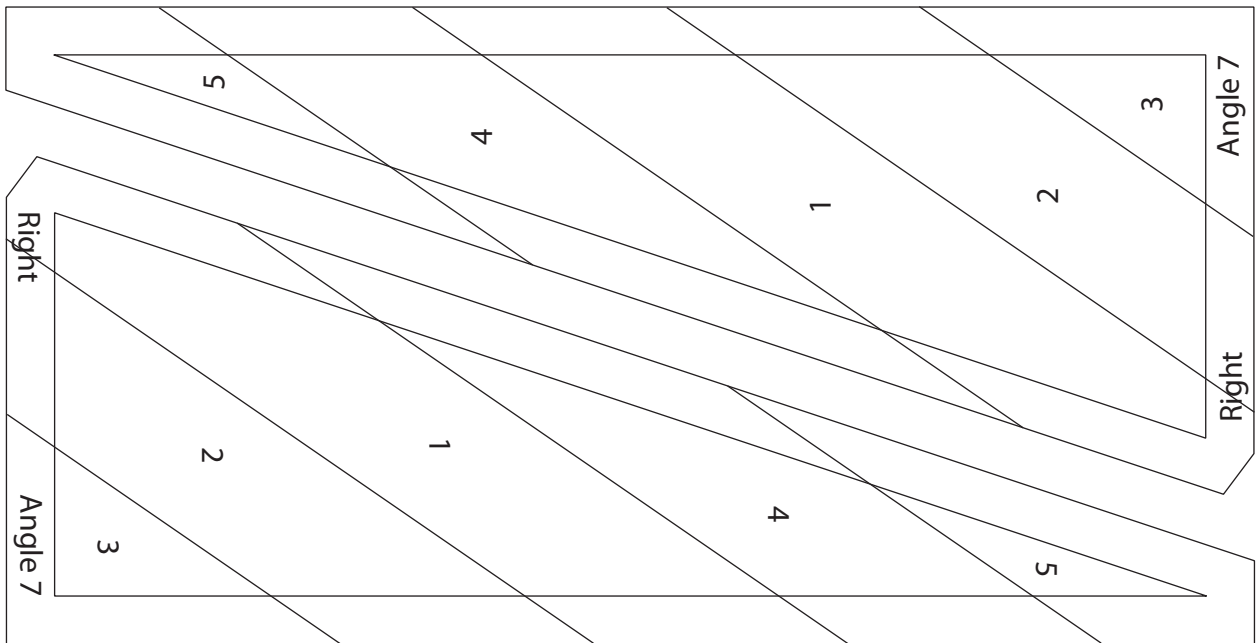
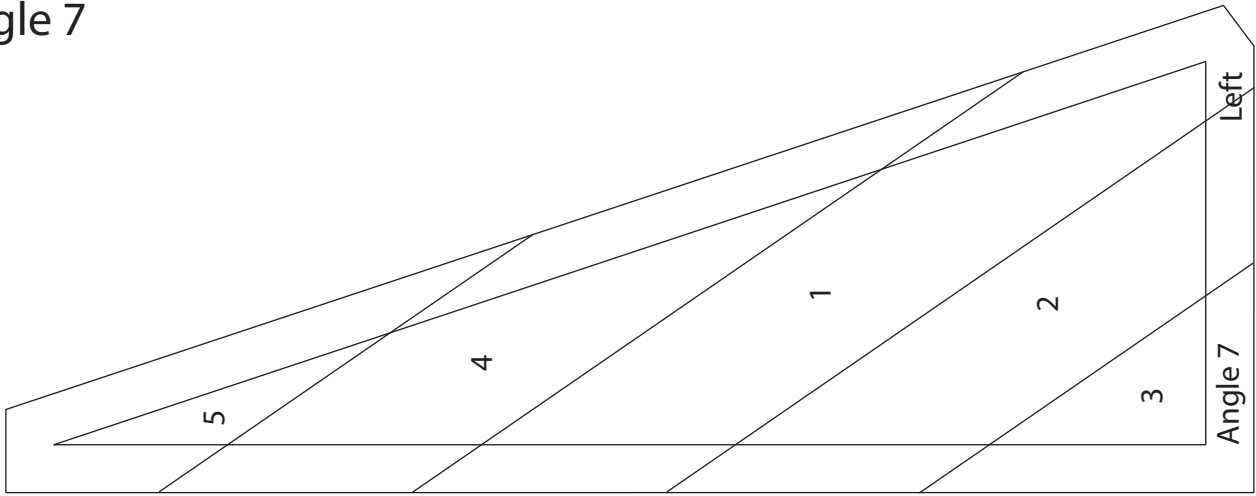

This box
should measure
1 inch square

The Big Woods Triangle foundations

Angle 8

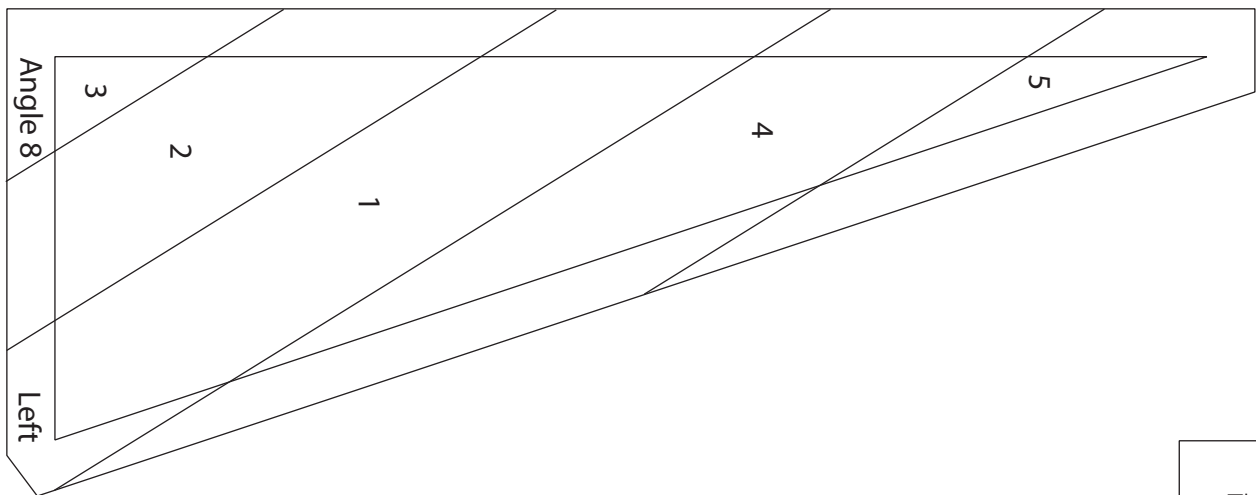
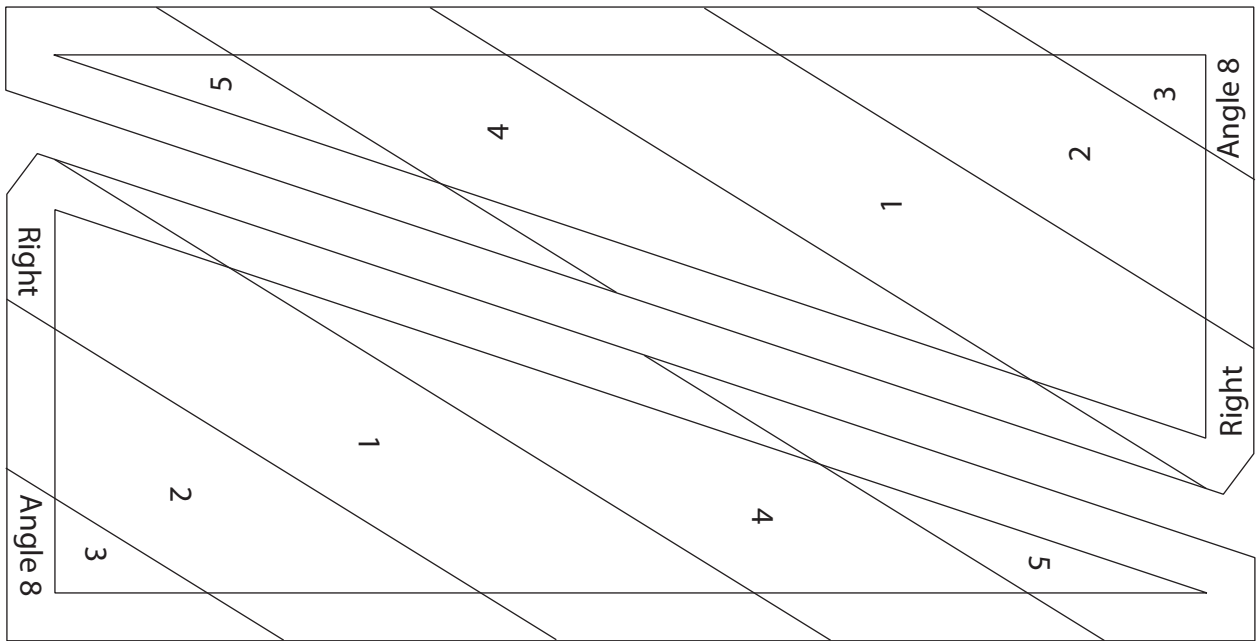
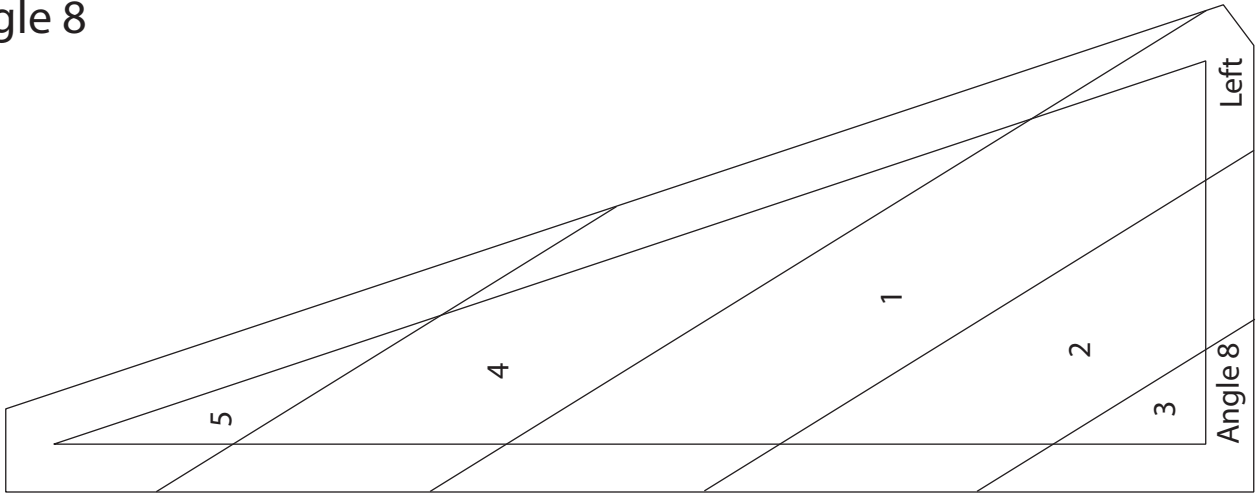

This box
should measure
1 inch square

The Big Woods Triangle foundations

Angle 9

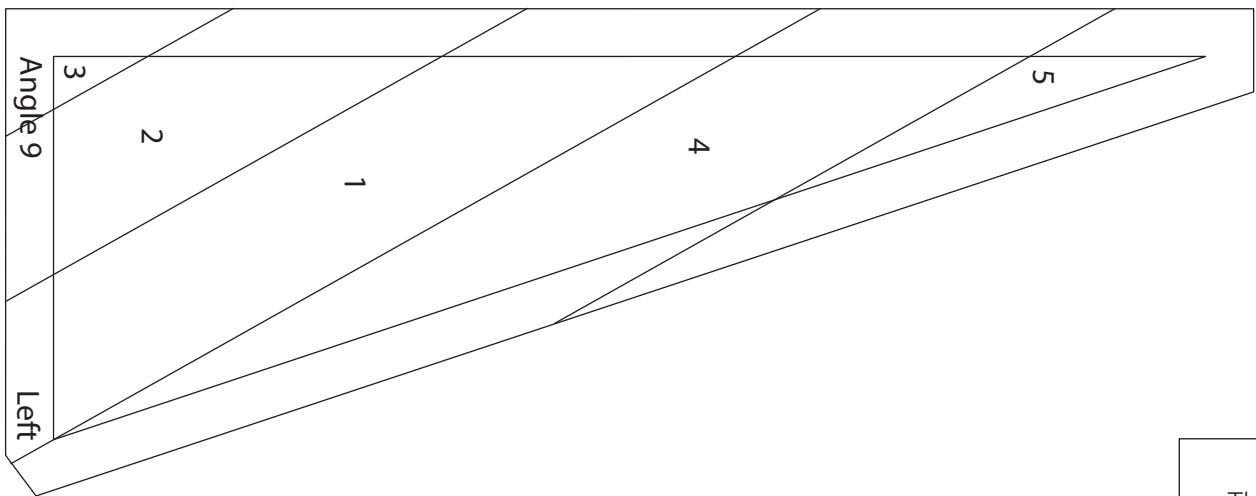
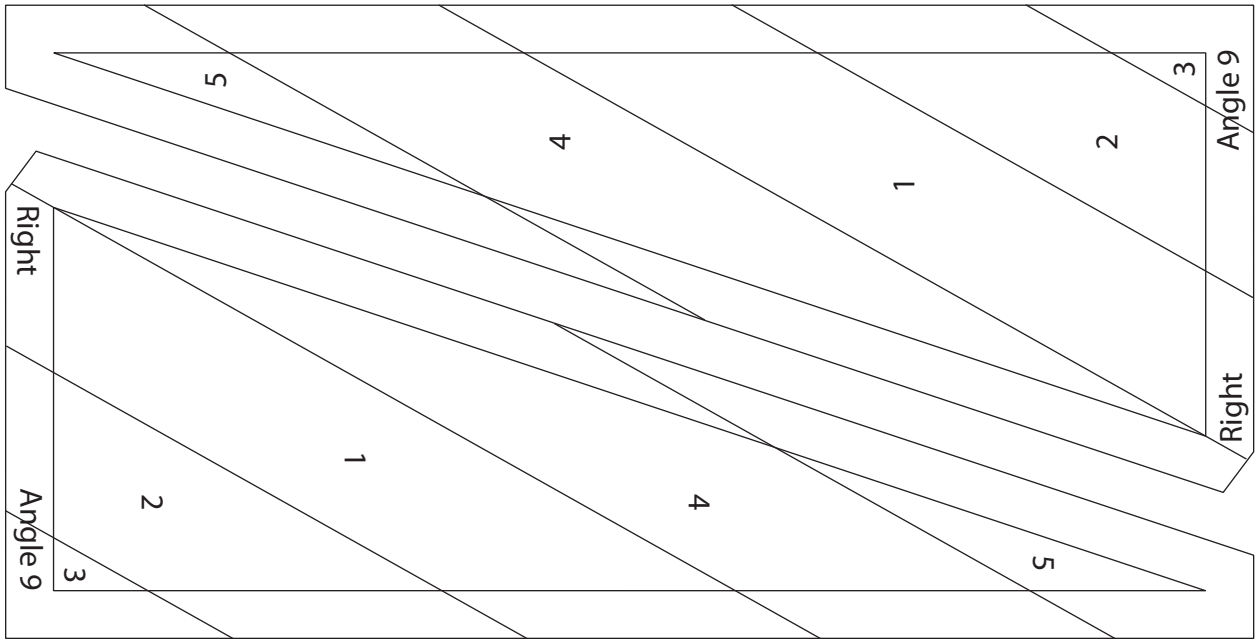
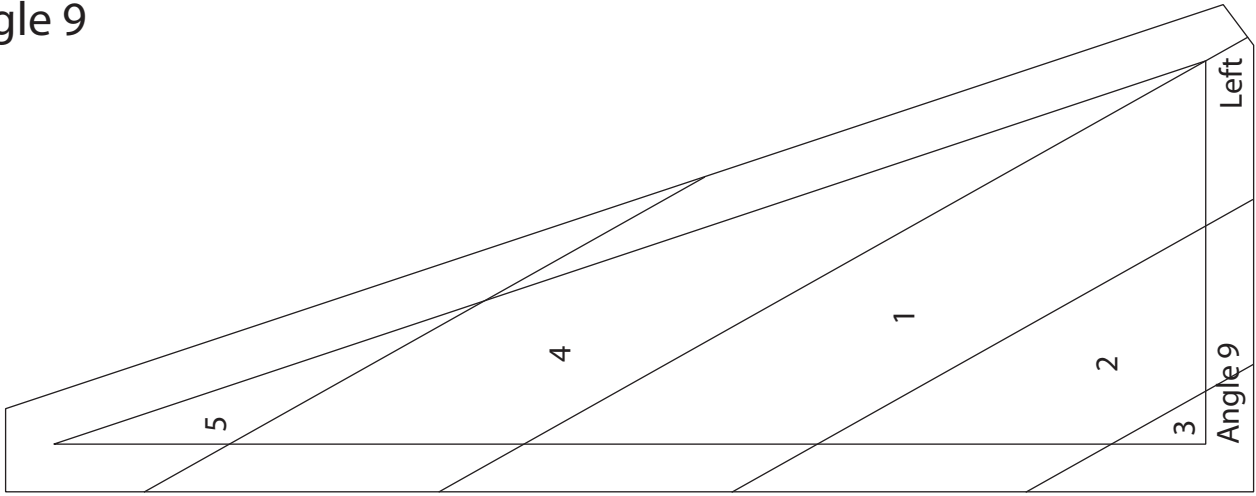

This box
should measure
1 inch square

The Big Woods Triangle foundations

Angle 10

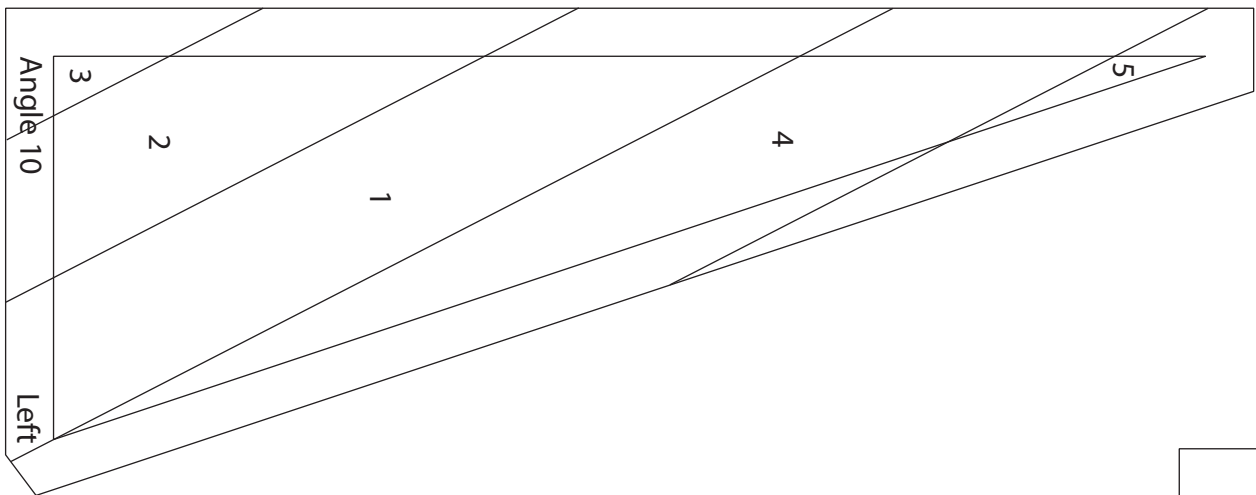
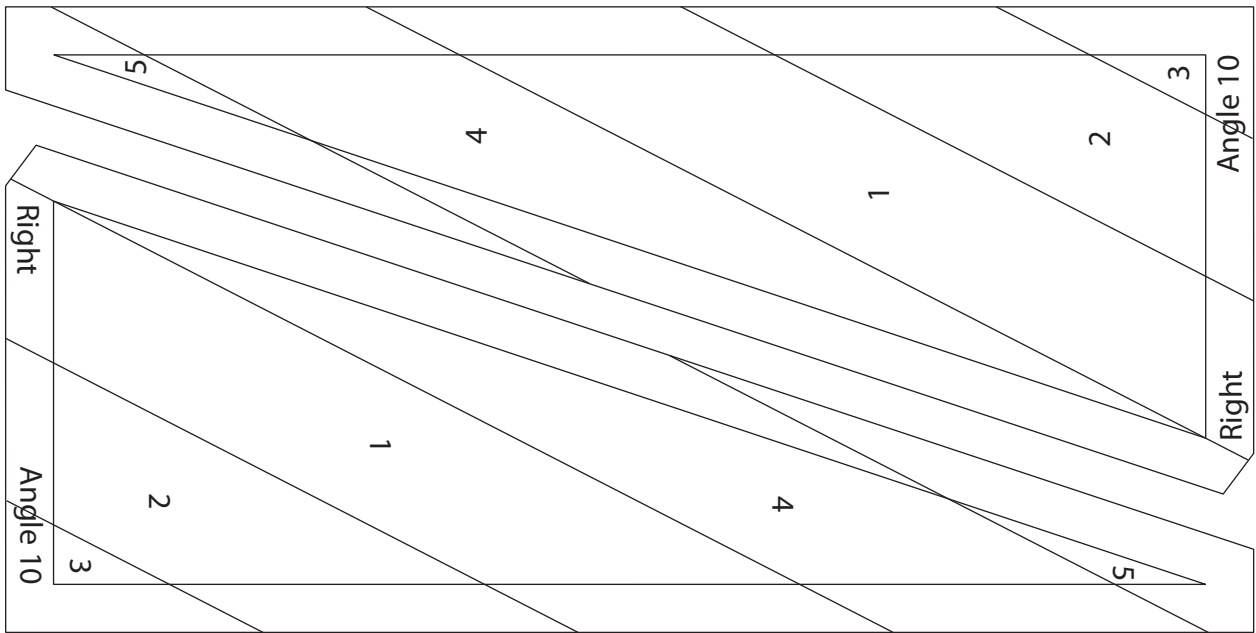
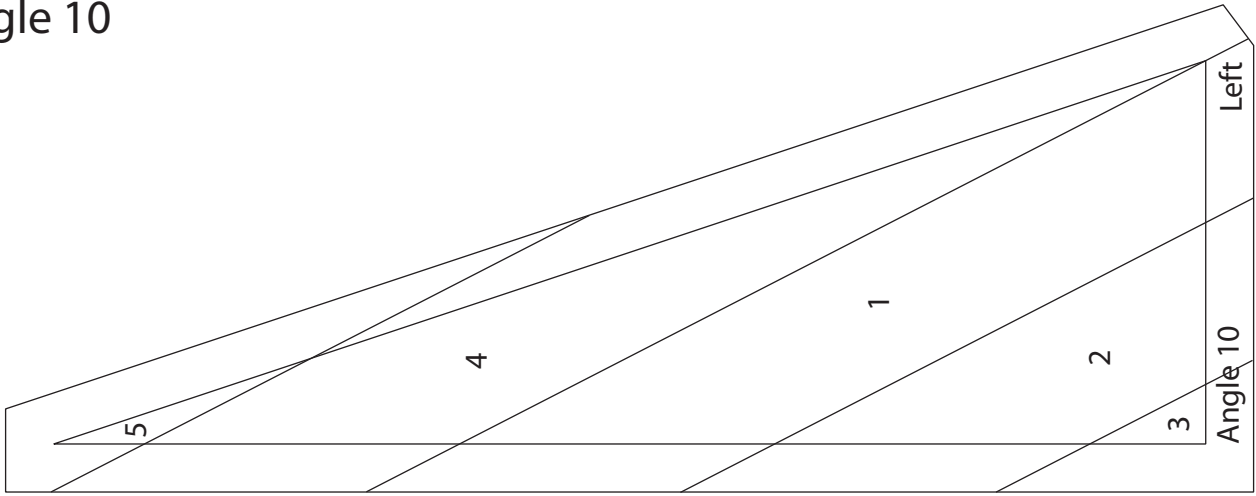

This box
should measure
1 inch square

The Big Woods Triangle foundations

Angle 11

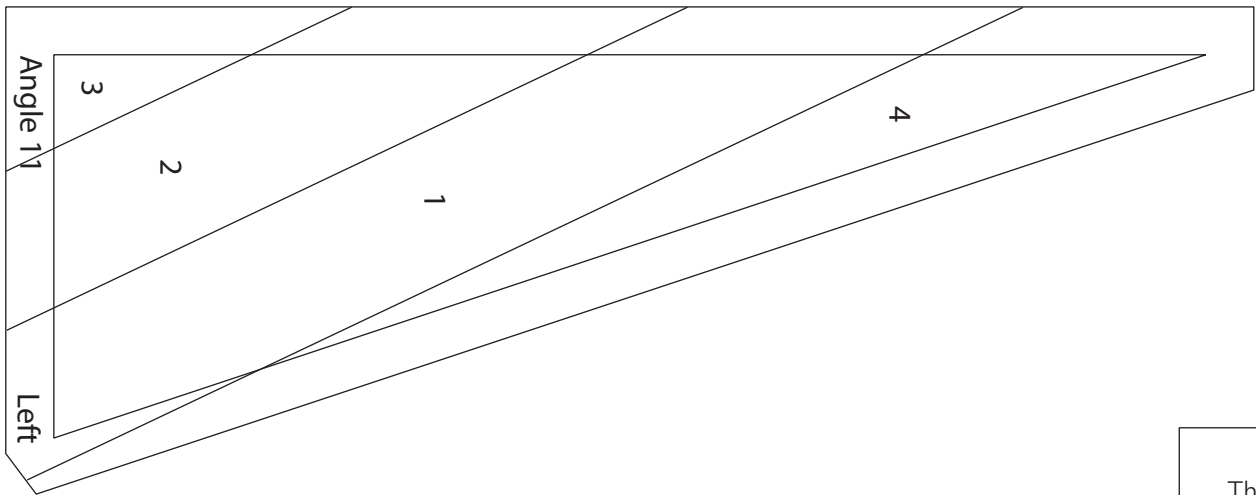
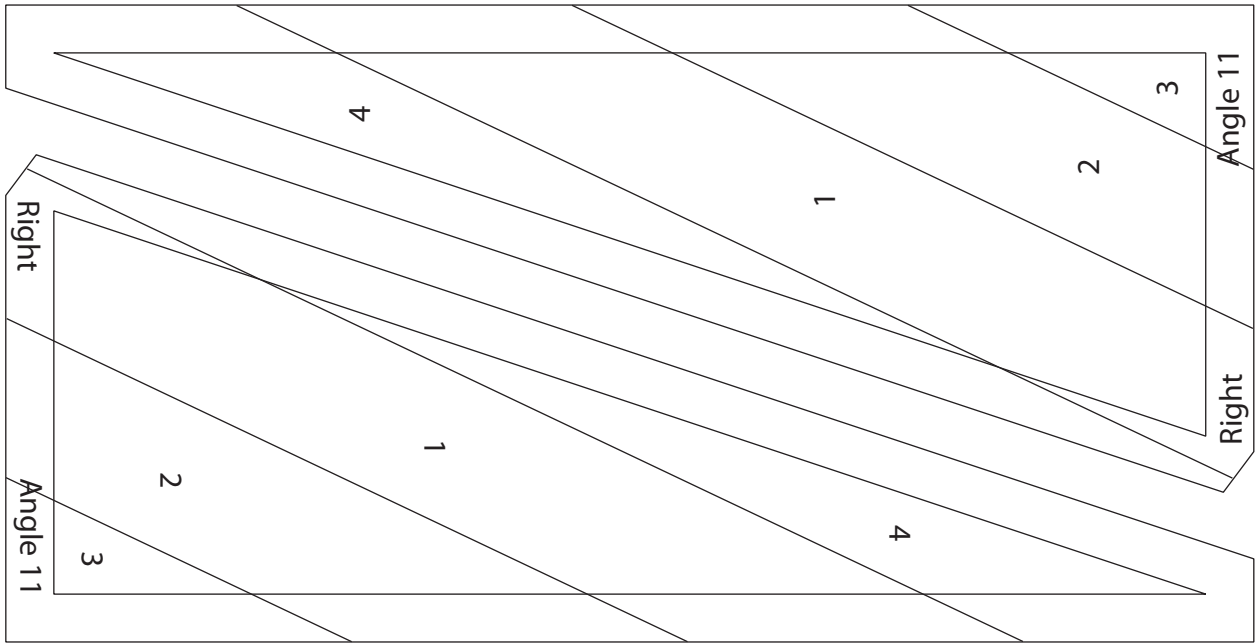
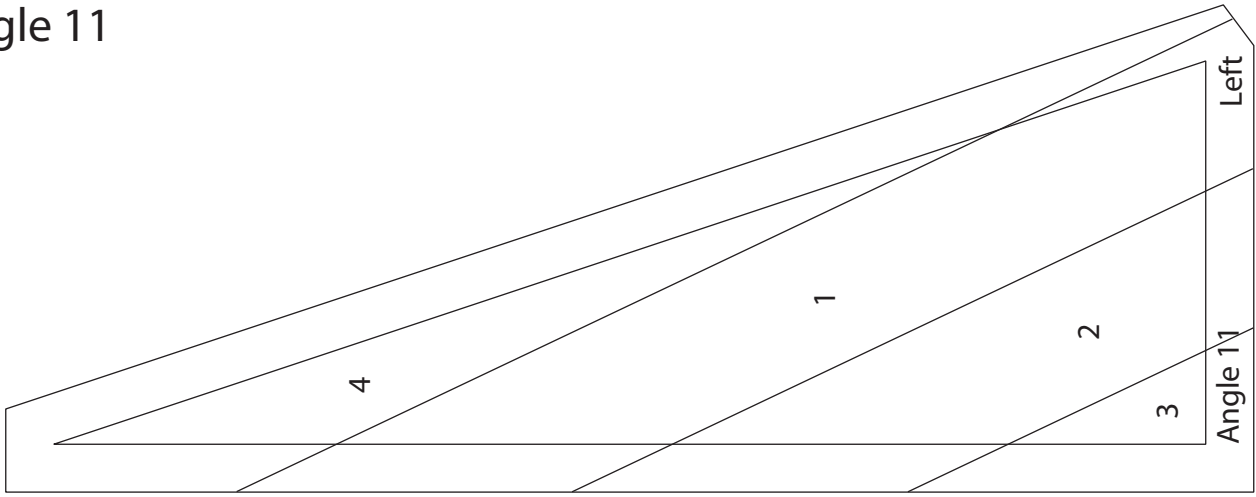

This box
should measure
1 inch square

The Big Woods Triangle foundations

Angle 12

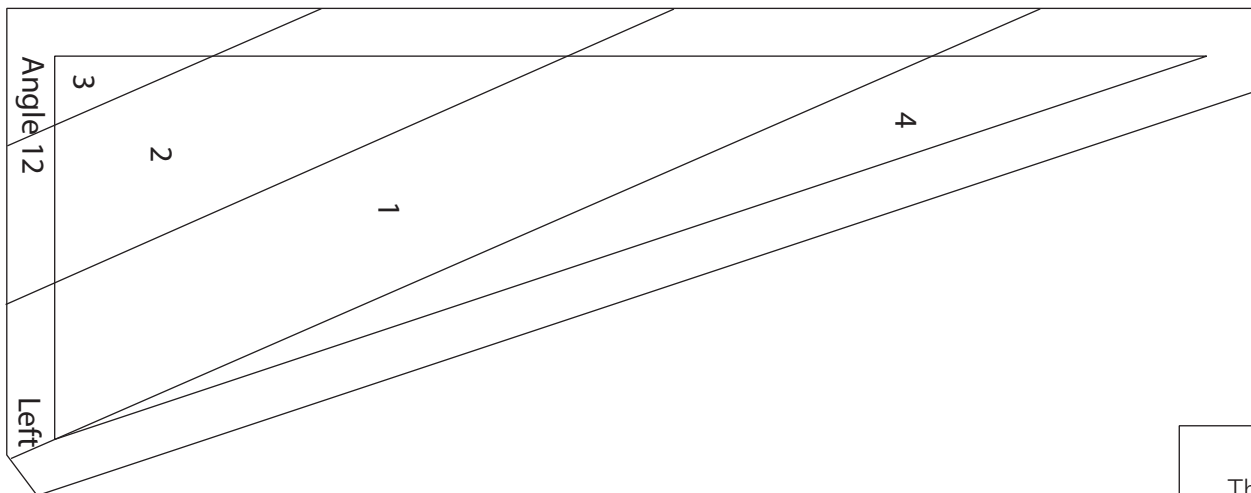
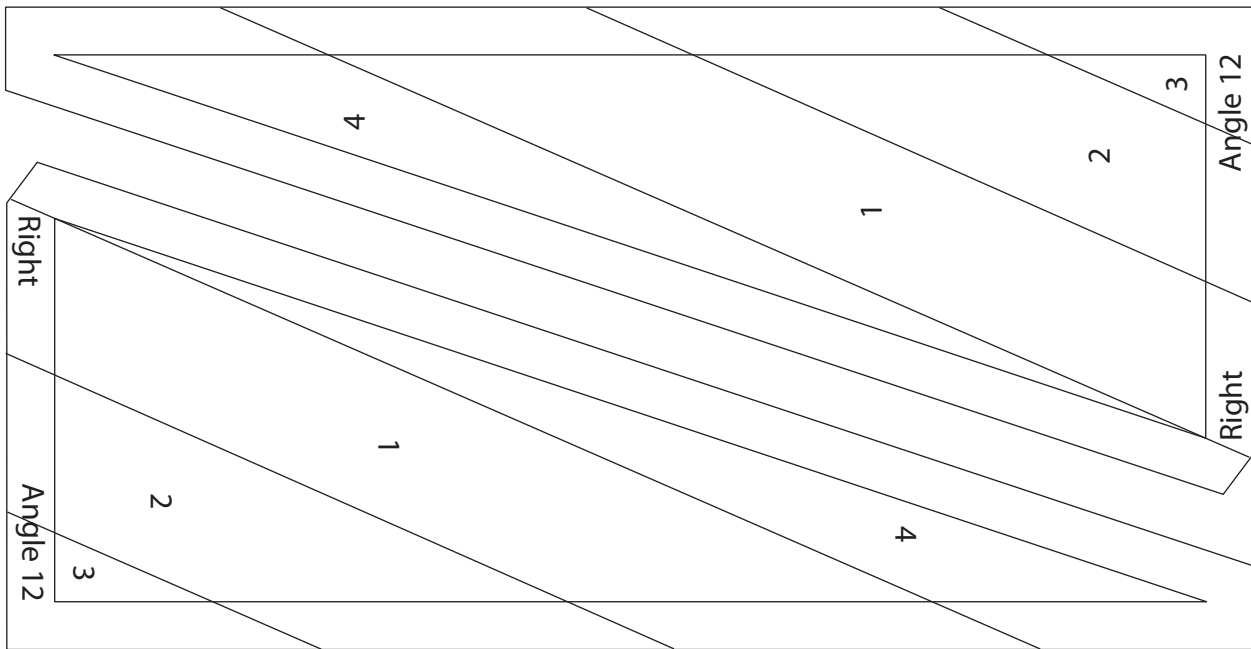
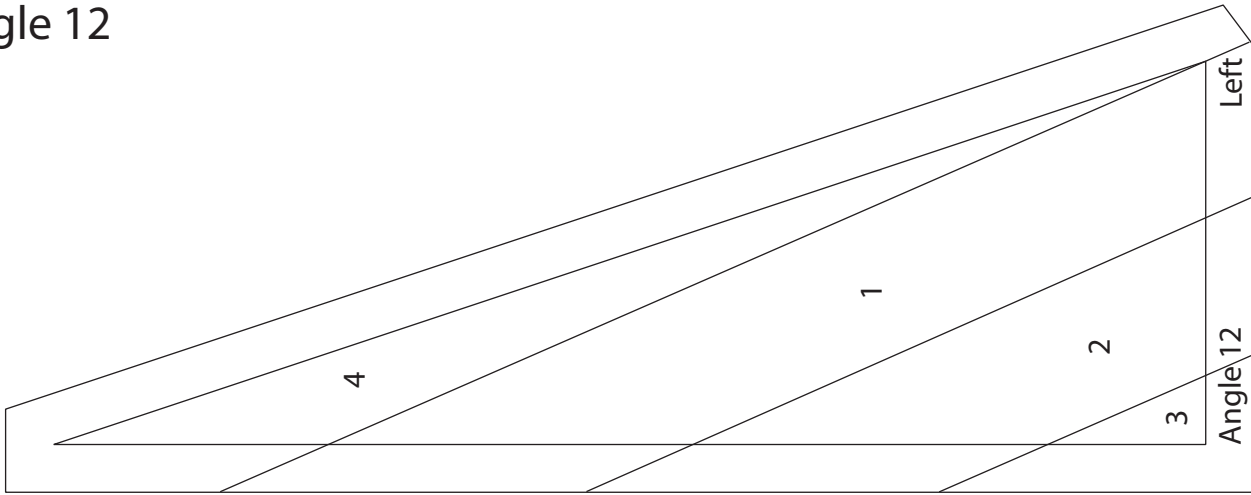

This box
should measure
1 inch square

The Big Woods Triangle foundations

Angle 13

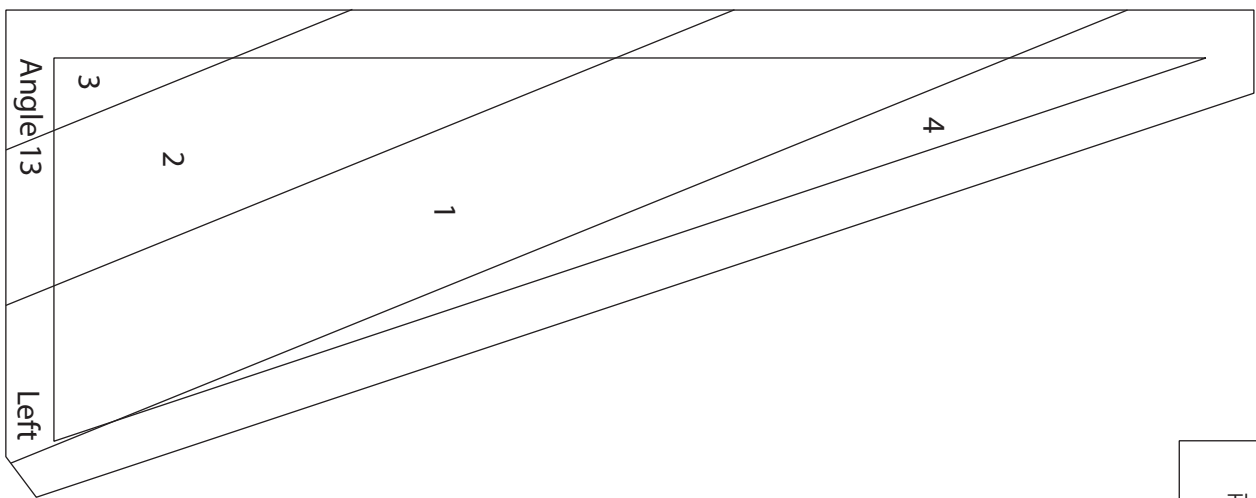
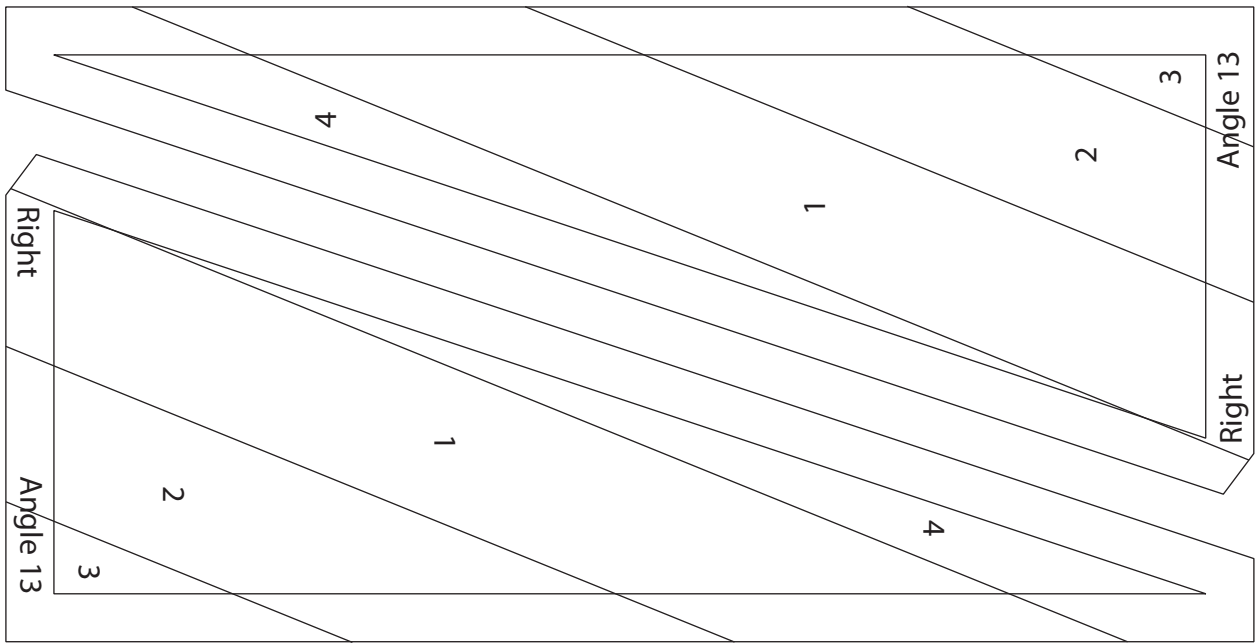
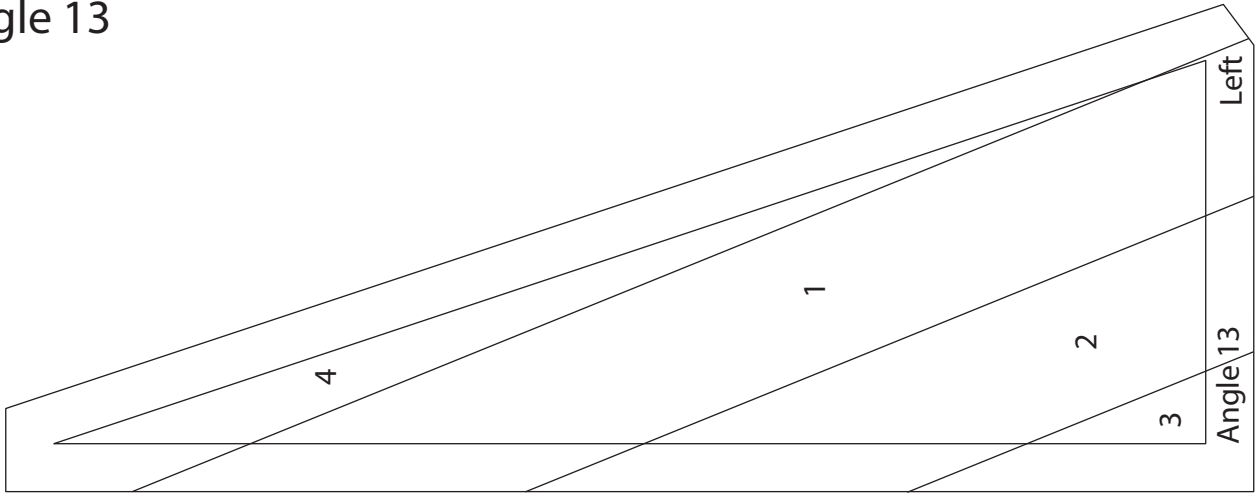

This box
should measure
1 inch square

The Big Woods Triangle foundations

Angle 14

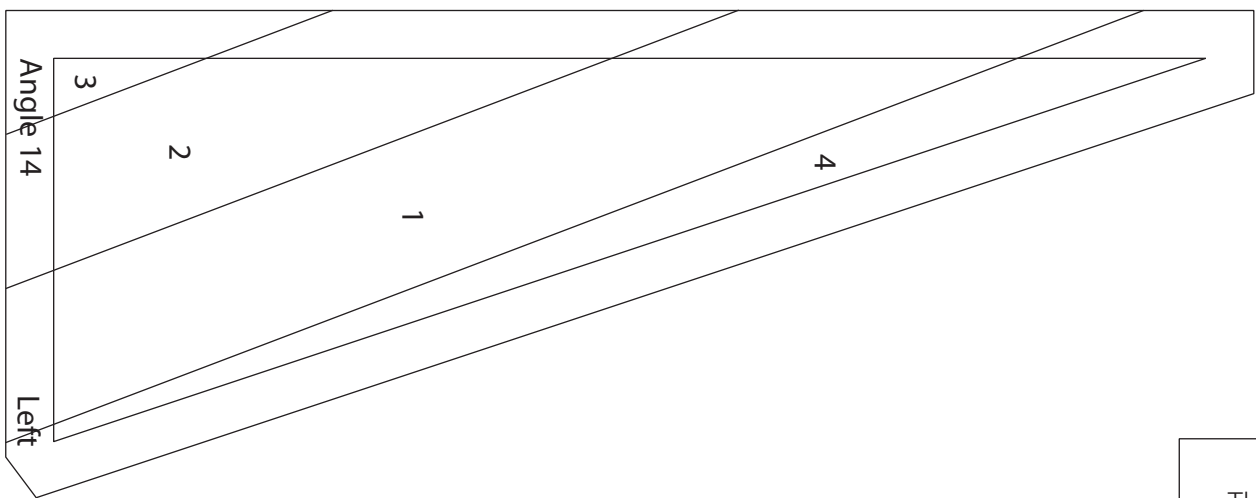
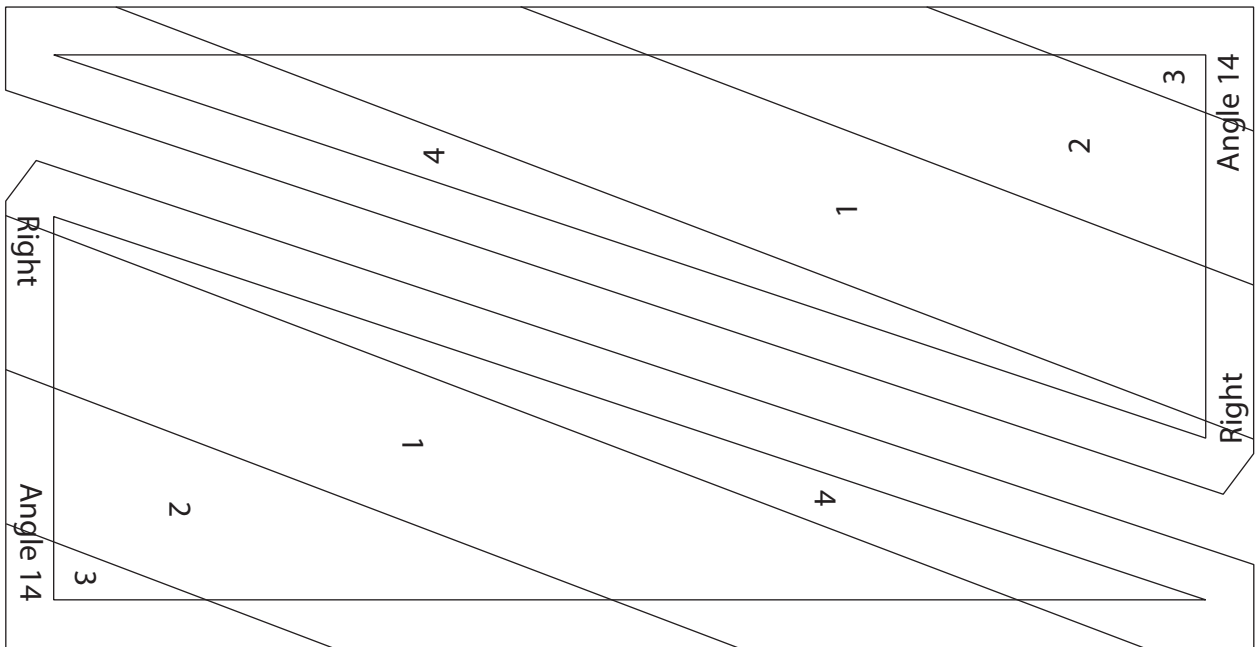
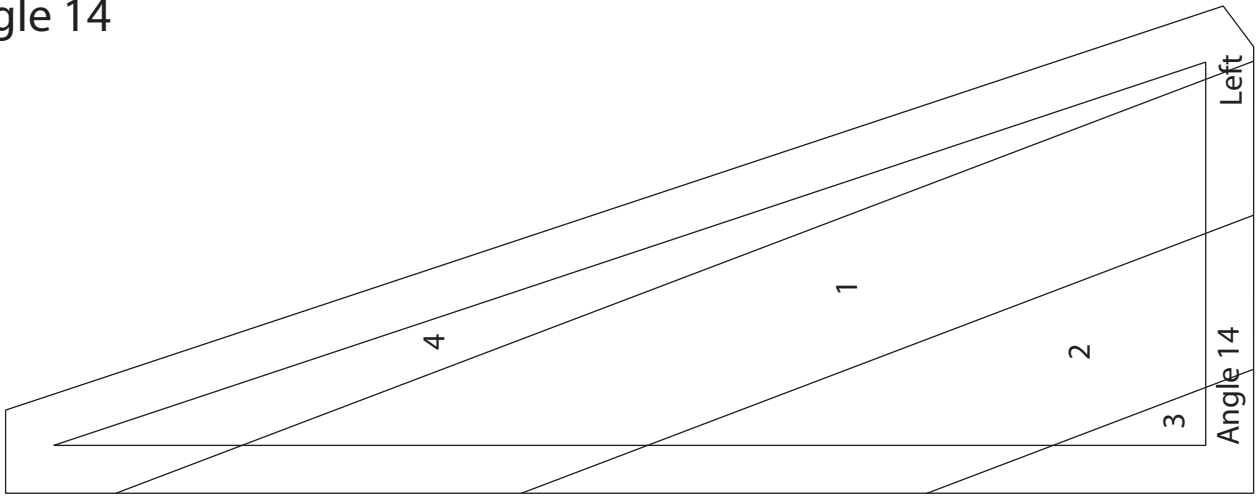

This box
should measure
1 inch square

The Big Woods Triangle foundations

Angle 15

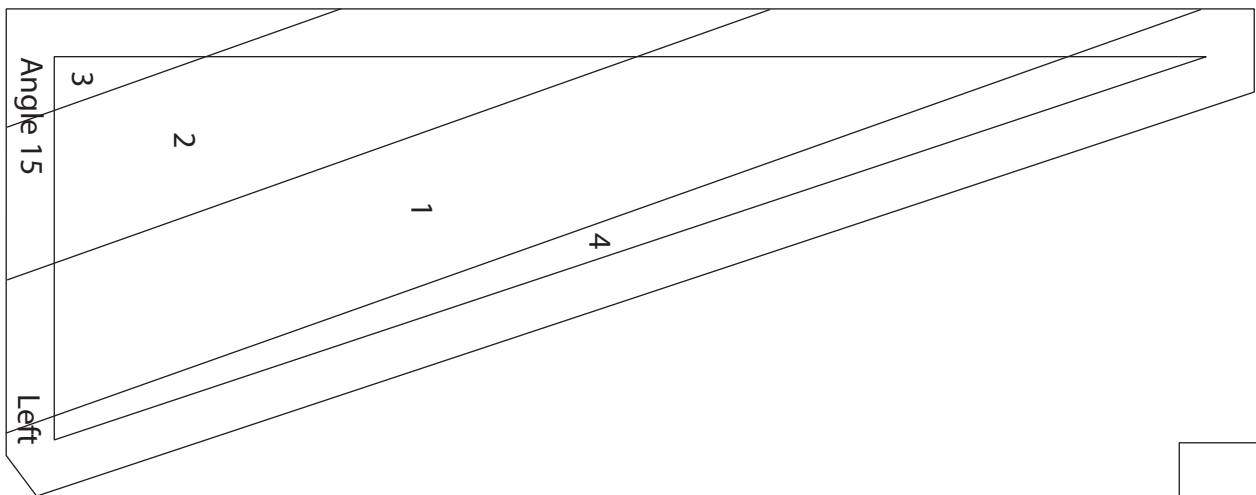
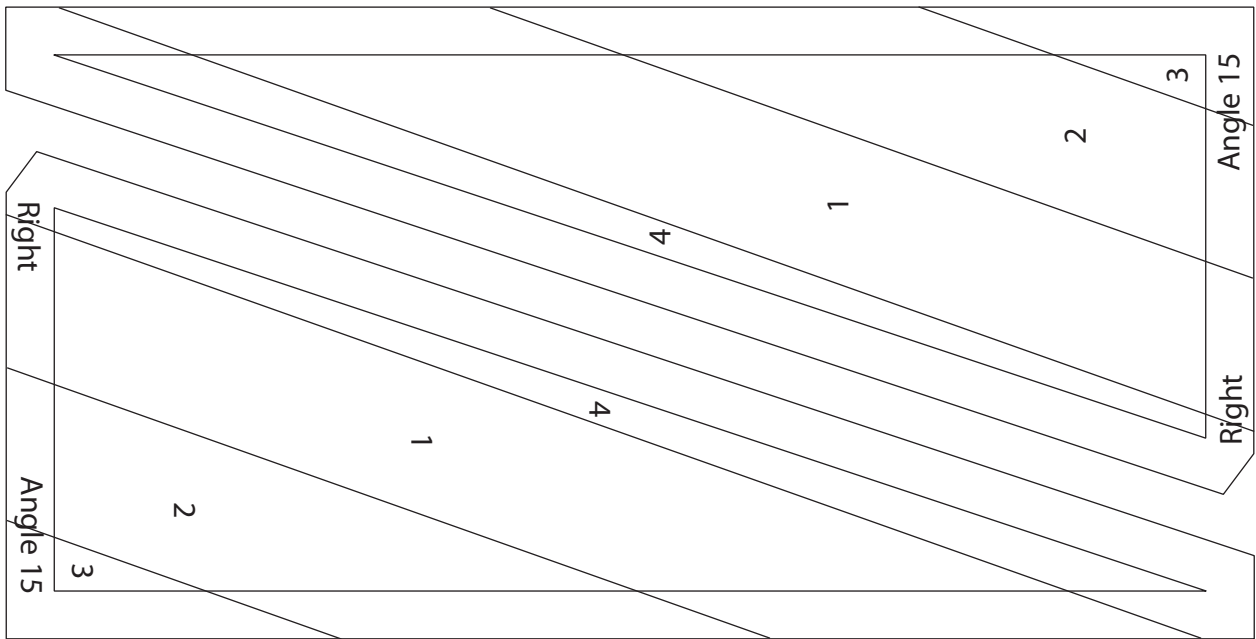
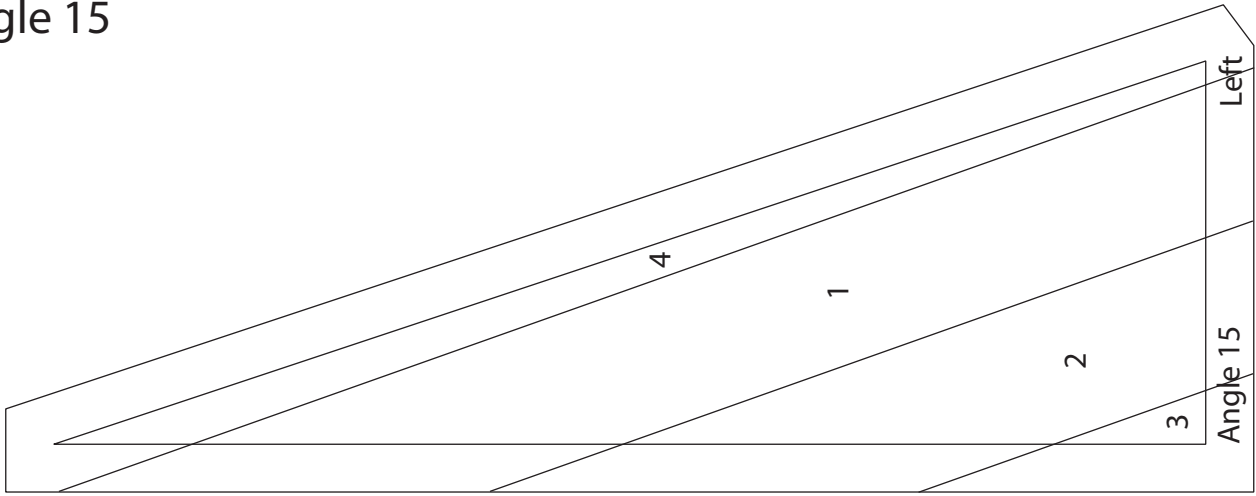

This box
should measure
1 inch square

The Big Woods Triangle foundations

Angle 16

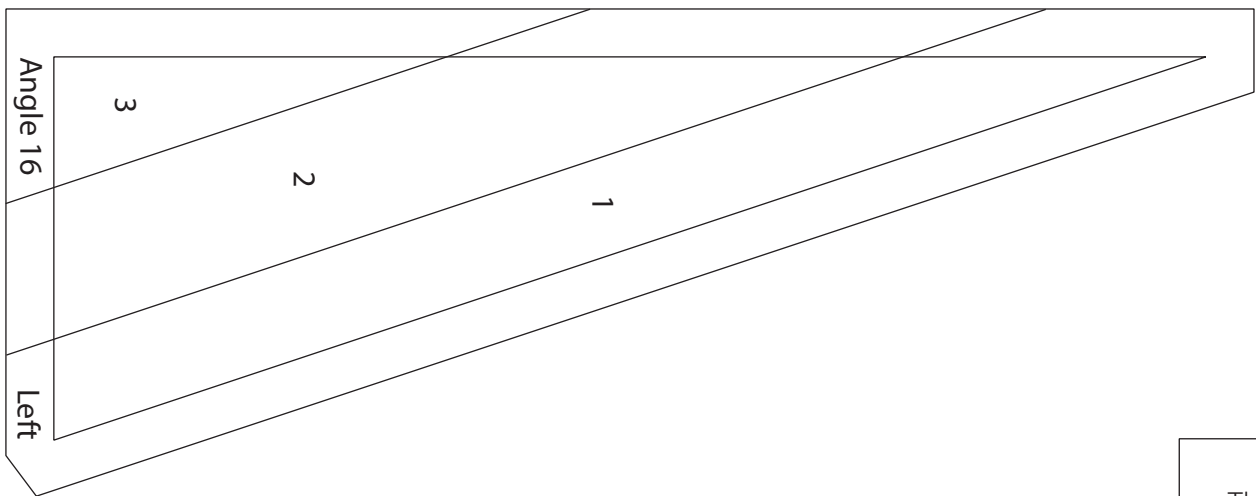
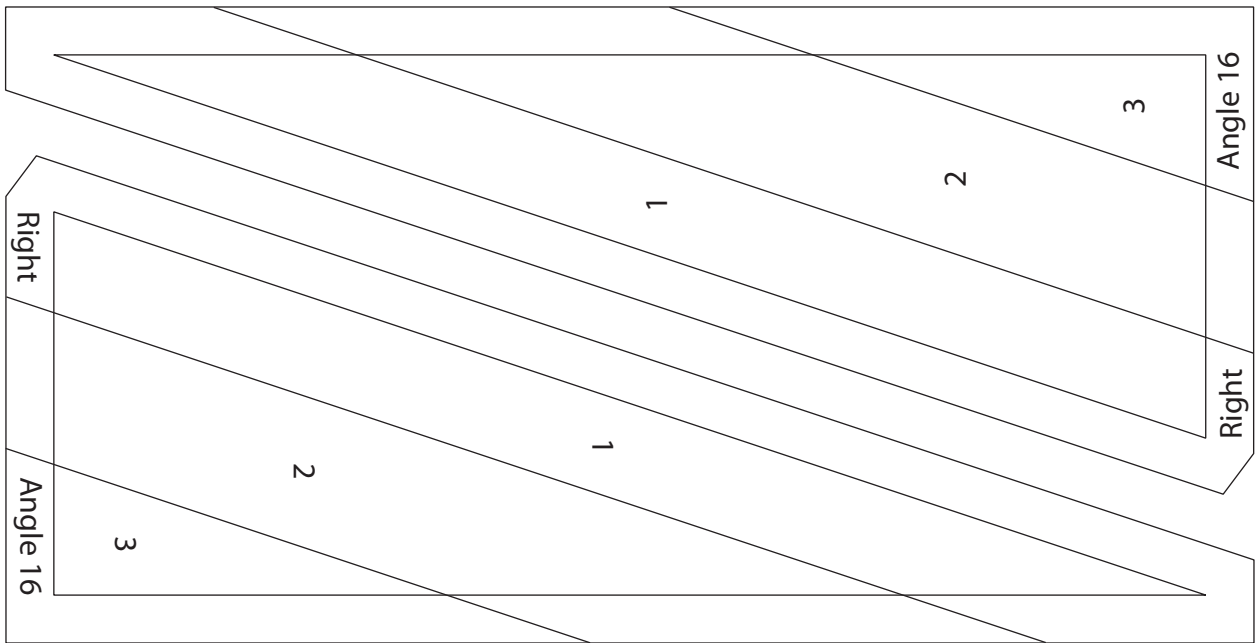
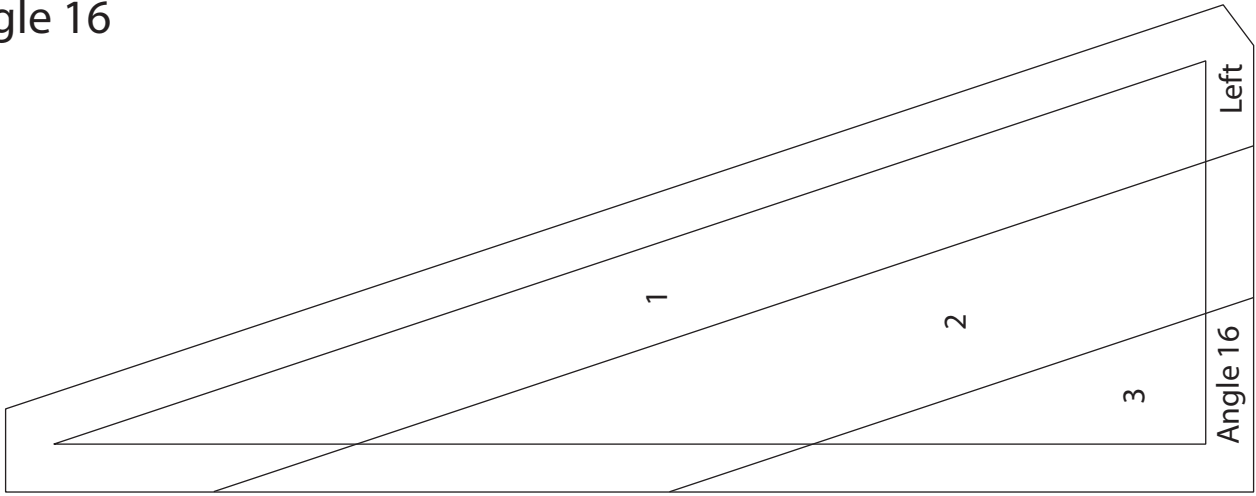

This box
should measure
1 inch square