

# Inkling



a little crispy



#112





# Inkling

a little crispy

Quilt designed, pieced, and quilted by Kristin Lawson.  
© Kristin Lawson 2014. All Rights Reserved.  
Cover quilt is approximately 67" x 67".

## Getting started

This pattern assumes that you have basic quilting knowledge. It does not provide directions for basic quilting techniques such as rotary cutting, sewing an accurate  $\frac{1}{4}$ " seam, pressing, pinning, basting, quilting, or binding.

Check out my latest patterns and other info at [alittlecrispy.com](http://alittlecrispy.com). For questions or comments, please contact me at [kristin@alittlecrispy.com](mailto:kristin@alittlecrispy.com).

## Materials

The only materials you need for this quilt are standard quilting supplies such as a sewing machine, thread, iron, marking pen or pencil, rotary cutter and rulers, and so on.

## Fabric

You will need a variety of 100% cotton quilting fabrics, 42" wide, as listed in the table below.

Please note that the fabric requirements below are calculated and the amounts listed do not have much of a "fudge factor" built in; I recommend purchasing slightly more than listed to allow for mistakes and crooked cuts.

Try choose a solid or a non-busy print for your background so that the design shows up well. Also, when choosing your colorful accent fabrics, make sure that they contrast well with the background fabric and each other.

There are two crib sizes listed below—one "easy" and one "hard". The "hard" layout is the same as the throw size, just using smaller pieces. The "easy" uses the same block size as the throw, but has only 9 blocks.

	Crib (easy)	Crib (hard)	Throw	Twin	Queen
Finished size	42" x 42"	42" x 42"	67" x 67"	71" x 92"	96" x 96"
Number of blocks	9 (12½" blocks)	25 (7½" blocks)	25 (12½" blocks)	35 (12½" blocks)	49 (12½" blocks)
Number of flowers	5	13	13	18	25
<b>Fabrics*</b>					
A (Light background)	$\frac{3}{4}$ yard	1 yard	2 yards	2 $\frac{3}{8}$ yards	3 $\frac{3}{4}$ yards
B (Dark background)	$\frac{7}{8}$ yard	1 yard	2 yards	2 $\frac{7}{8}$ yards	4 $\frac{1}{8}$ yards
C (Dark background accent)	$\frac{1}{4}$ yard	$\frac{1}{4}$ yard	$\frac{3}{8}$ yard	$\frac{1}{2}$ yard	$\frac{5}{8}$ yard
D (Flowers)	Scraps (four 3" x 5½" per flower), or about $\frac{1}{3}$ yard total	Scraps (four 2" x 3½" per flower), or about $\frac{1}{3}$ yard total	Scraps (four 3" x 5½" per flower), or about $\frac{3}{4}$ yard total	Scraps (four 3" x 5½" per flower), or about 1 yard total	Scraps (four 3" x 5½" per flower), or about 1½ yard total
E (Flower centers)	$\frac{1}{8}$ yard	$\frac{1}{8}$ yard	$\frac{1}{8}$ yard	$\frac{1}{4}$ yard	$\frac{1}{4}$ yard
F (Star block red accent)	$\frac{1}{8}$ yard	$\frac{1}{4}$ yard	$\frac{1}{4}$ yard	$\frac{1}{3}$ yard	$\frac{1}{2}$ yard
<b>Other fabrics</b>					
Binding**	$\frac{1}{2}$ yard	$\frac{1}{2}$ yard	$\frac{5}{8}$ yard	$\frac{3}{4}$ yard	$\frac{7}{8}$ yard
Backing	2 $\frac{3}{4}$ yards	2 $\frac{3}{4}$ yards	4 $\frac{1}{4}$ yards	5½ yards	8½ yards
Batting	46" x 46"	46" x 46"	71" x 71"	75" x 96"	100" x 100"

\*Refer to the next page for more info on color selection.

\*\*Binding amount assumes 2½" strips, cut the width of fabric. You will need additional fabric if you choose to cut your fabric on the bias.

There are a coloring sheets towards the end of this pattern (pages 13 to 16)—feel free to use any color combination you love!

The fabrics used in the cover quilt are Kona cottons:

- A:** PFD                    **D:** Assorted reds, magentas, and violets  
**B:** Prussian            **E:** Sunny  
**C:** Celestial            **F:** Lipstick

## Cutting

All measurements include ¼" seam allowances.

Refer to the cutting diagrams at the end of this pattern to help you make efficient cuts from your fabric. I did not include cutting instructions for the scrappy D fabrics. Diagrams for the Crib (easy) are on page 17, Crib (hard) on page 18, Throw on page 19, Twin on page 20, and Queen on page 21.

Cut out your fabric as listed in the table below.

<b>Crib (easy)</b>			
Color	Size	Number	Block
A	3" x 8"	16	Y
	3" x 5½"	20	X
	3" x 3"	20	X
	4" x 4"	4	Y
B	3" x 3"	68	20 X, 48 Y
	4" x 4"	8	Y
	2½" x 38"	2	Border
	2½" x 42"	2	Border
C	3" x 3"	16	Y
D	3" x 5½"	20	X
E	3" x 3"	5	X
F	3" x 3"	4	Y
	4" x 4"	4	Y

<b>Crib (hard)</b>			
Color	Size	Number	Block
A	2" x 5"	48	Y
	2" x 3½"	52	X
	2" x 2"	52	X
	3" x 3"	12	Y
B	2" x 2"	196	52 X, 144 Y
	3" x 3"	24	Y
	2½" x 38"	2	Border
	2½" x 42"	2	Border
C	2" x 2"	48	Y
D	2" x 3½"	52	X
E	2" x 2"	13	X
F	2" x 2"	12	Y
	3" x 3"	12	Y

<b>Throw</b>			
Color	Size	Number	Block
A	3" x 8"	48	Y
	3" x 5½"	52	X
	3" x 3"	52	X
	4" x 4"	12	Y
B	3" x 3"	196	52 X, 144 Y
	4" x 4"	24	Y
	2½" x 63"	2	Border
	2½" x 67"	2	Border
C	3" x 3"	48	Y
D	3" x 5½"	52	X
E	3" x 3"	13	X
F	3" x 3"	12	Y
	4" x 4"	12	Y

<b>Twin</b>			
Color	Size	Number	Block
A	3" x 8"	68	Y
	3" x 5½"	72	X
	3" x 3"	72	X
	4" x 4"	17	Y
B	3" x 3"	276	72 X, 204 Y
	4" x 4"	34	Y
	4½" x 88"	2	Border
	2½" x 71"	2	Border
C	3" x 3"	68	Y
D	3" x 5½"	72	X
E	3" x 3"	18	X
F	3" x 3"	17	Y
	4" x 4"	17	Y

<b>Queen</b>			
Color	Size	Number	Block
A	3" x 8"	96	Y
	3" x 5½"	100	X
	3" x 3"	100	X
	4" x 4"	24	Y
B	3" x 3"	388	100 X, 288 Y
	4" x 4"	48	Y
	4½" x 88"	2	Border
	4½" x 96"	2	Border
C	3" x 3"	96	Y
D	3" x 5½"	100	X
E	3" x 3"	25	X
F	3" x 3"	24	Y
	4" x 4"	24	Y

# Sewing your blocks

All seam allowances are  $\frac{1}{4}$ ". Block sizes are 7.5" finished (Crib (hard)), or 12.5" finished (all other sizes).

There are two different blocks in this quilt, Block X and Block Y.

## Sew X blocks

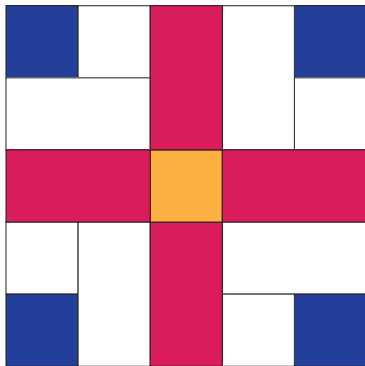

The instructions below are for one block. You need to make this many for each size:

- Crib (easy): 5
- Crib (hard): 13
- Throw: 13
- Twin: 18
- Queen: 25

The sizes listed below are for all versions, except for the crib (hard) size, which are given in parentheses.

**1** Sew one 3" (2") A square to a 3" (2") B square. Press towards the darker fabric. Repeat three more times.

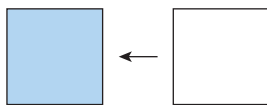

**2** Sew a component from step 1 to a 3" x 5½" (2" x 3½") A rectangle, noting the orientation of the B square relative to the rectangle. Either press towards the darker fabric or open. Repeat three more times.

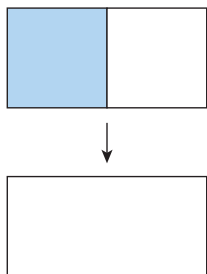

**3** Sew one of the components from step 2 to each side of a 3" x 5½" (2" x 3½") D rectangle. Press towards the D fabric. Repeat one more time.

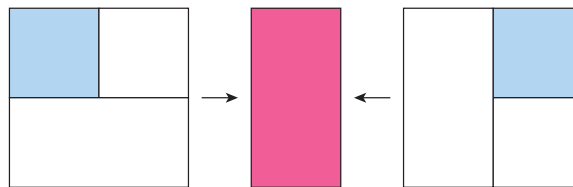

**4** Sew one 3" x 5½" (2" x 3½") D rectangle to either side of a 3" x 3" (2" x 2") E square. Press towards the D fabric.



**5** Finish assembling the block as shown in the illustration below.

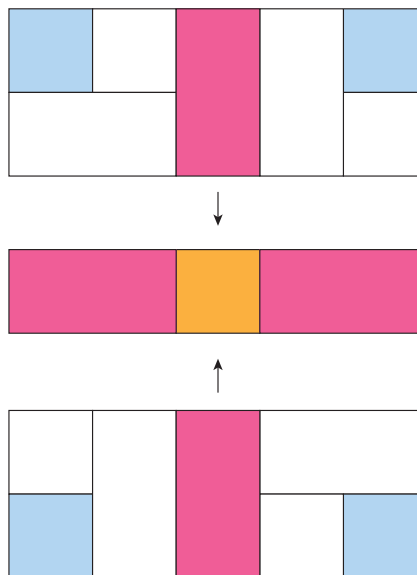

## Sew Y blocks

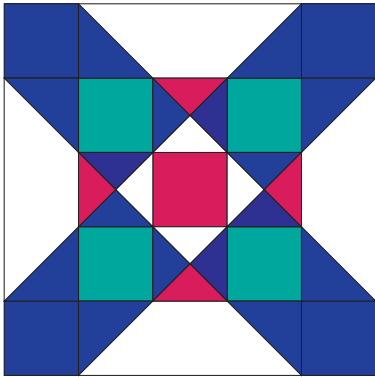

The Y blocks have hourglass and “elongated geese” components, which you sew first before assembling the block.

## Sew your hourglass components

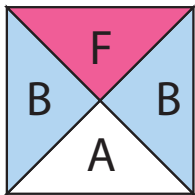

The sizes of hourglass components in this quilt are:

- 1½" finished (2" unfinished) for the Crib (hard),
- 2½" finished (3" unfinished) for all other sizes.

Make your hourglass blocks:

**1** Using the chart below, match up pairs of fabric with right sides together. Use 3" squares for the Crib (hard), and 4" squares for all other sizes.

	A + B	B + F
Crib (easy)	4	4
Crib (hard)	12	12
Throw	12	12
Twin	17	17
Queen	24	24

**2** Draw a line diagonally across the center back of the lighter of each pair, and sew a line ¼" away from either side of the line (sewing the pair together).

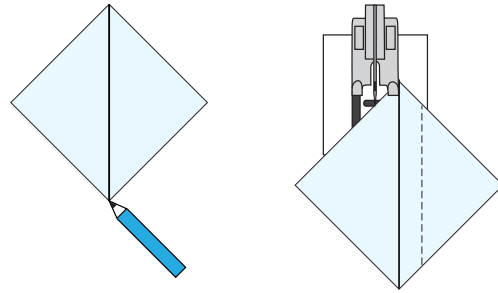

**3** Cut your squares in half down the middle (no need to be precise) to get two half square triangles (HSTs) per pair. Press your seams toward the darker fabric. Don't use steam as this will distort your block.

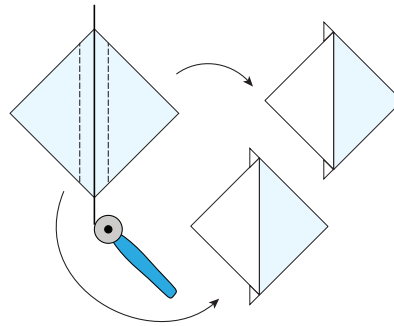

**4** Align a ruler with two corners of the block and carefully cut all of your HSTs in half as shown in the illustration below.

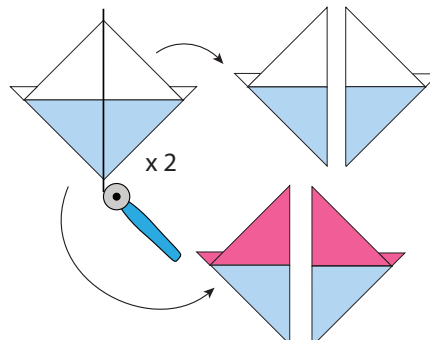

**5** Sew your half HSTs together to make hourglass shapes with one A, two B, and one F triangles. Nest the seams and sew the two halves together.

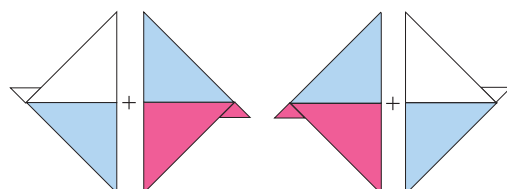

**6** If you have been pressing to the side, on the back of your blocks, pop open the few stitches that extend beyond the cross seam (as illustrated below) and “spin” your seams to reduce bulk.

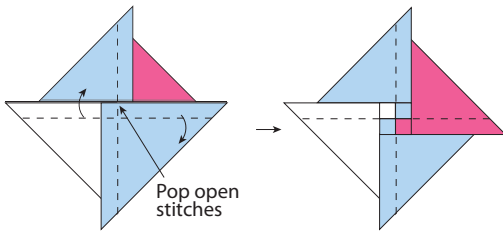

**7** Trim your hourglass blocks to 2" square (Crib (hard)), or 3" square (all other sizes), making sure that the center point of the block stays in the very center. Do this by lining up the center point of the block with the intersection of the horizontal and vertical marks as illustrated below for all sizes except the Crib (hard). Use the following marks:

- 1" marks (Crib (hard)),
- 1.5" marks (all other sizes).

Use a ruler that has a diagonal line to help keep the diagonal line of the block centered. Trim all sides to clip off the “rabbit ears” (little points that stick out from the block).

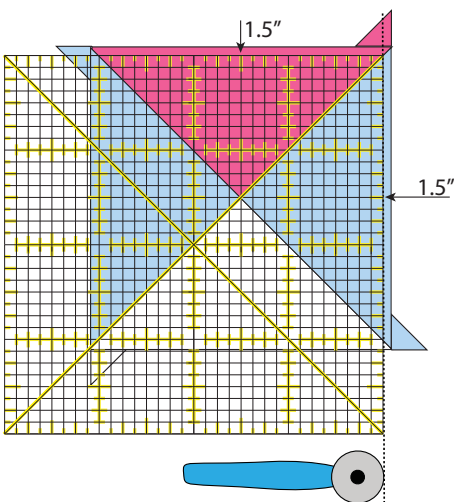

## Sew your elongated geese components

The sizes of elongated geese components in this quilt are:

- 1½" x 4½" finished (2" x 5" unfinished): Crib (hard),
- 2½" x 7½" finished (3" x 8" unfinished): all other sizes

The sizes listed below are for all versions, except for the Crib (hard) sizes, which are given in parentheses.

Make your elongated geese components:

**1** Mark a diagonal line on the back of some of your 3" (2") B squares: 32 (Crib, easy), 96 (Crib (hard) and Throw), 136 (Twin), or 192 (Queen).

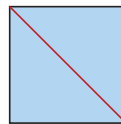

**2** Place one 3" (2") B square in the corner of a 3" x 8" (2" x 5") A rectangle, right sides together. Sew across the diagonal line.



**3** Trim away the extra triangle from the corner by cutting approximately ¼" away from the seam you just sewed.

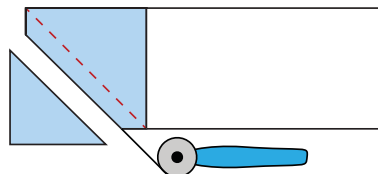

**4** Press the seam toward the darker fabric or open.



**5** Place a second 3" (2") B square on the opposite corner of the rectangle, noting carefully the orientation of the diagonal line compared to the previous one. Sew across the diagonal line.



**6** Again, trim the extra triangle away and press.

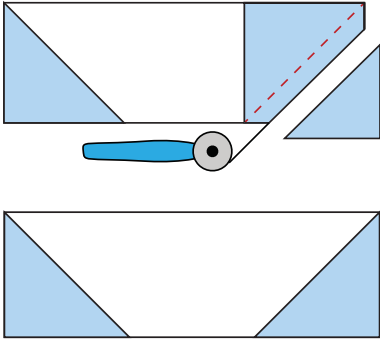

### Finish assembling the Y blocks

The instructions below are for one block. You need to make this many for each size:

- Crib (easy): 4
- Crib (hard): 12
- Throw: 12
- Twin: 17
- Queen: 24

Finish assembling the Y block:

**1** Sew the 3" (2") C and F squares to your hourglass components in columns. Press away from the hourglass components.

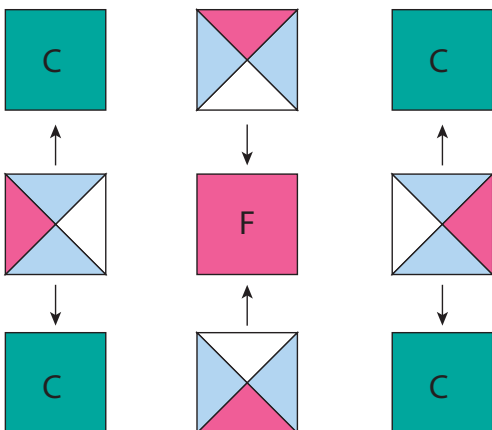

**2** Sew the columns from step 1 together. Press your seams open.

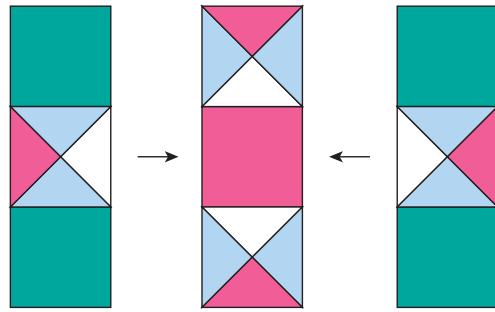

**3** Sew 3" (2") B squares to either side of half of the elongated geese components. Sew the remaining half of the elongated geese components to either side of the component from step 2.

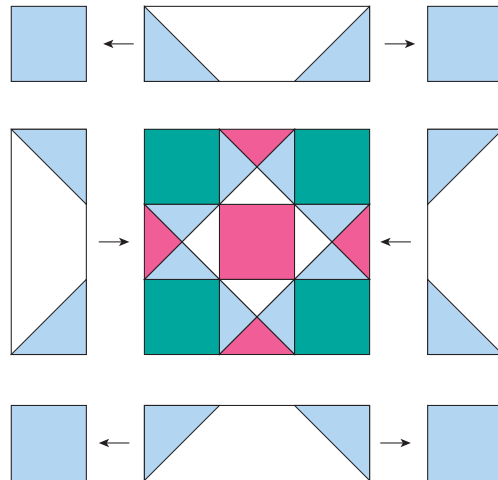

**4** Sew the three rows from step 3 together.

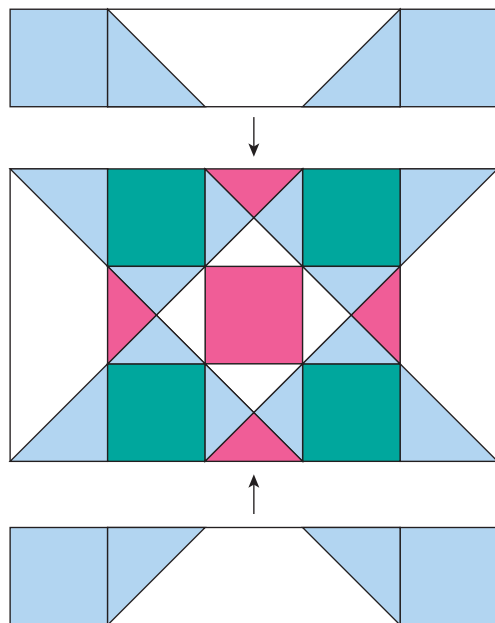

# Assembling your quilt top

---

Sew the rest of your quilt top together following the assembly diagrams on page 9-12.

## Quilting & Finishing

---

When you are done the quilt top, press it well from both sides.

Layer your well-pressed quilt top with your batting and backing and baste your quilt.

Quilt it with whatever pattern you find pleasing. I quilted mine with a medium-sized meander using a 40 weight variegated King Tut thread. If you prefer for your quilting thread to not stand out, I find that by using a very thin thread like Aurifil 50 weight, when the quilt is washed you can barely see the quilting, even on the dark colors. If you used linen or shot cottons in your quilt, keep your quilting somewhat dense as both of these fabrics have a tendency to fray.

After you have quilted your quilt, square it off so the edges are nice and straight, and then sew on your binding. Wash and enjoy!



# Final assembly: Crib (easy)

B

B	A		D	A	B
A					A
D			E		D
A					A
B	A	D		A	B

B	B	A	B	B
B	C	<del>F</del> <del>B</del> A	C	B
A	<del>F</del> <del>B</del> A	F	<del>A</del> <del>B</del> F	A
B	C	<del>B</del> <del>A</del> B	C	B
B	B	A	B	B

B	A		D	A	B
A					A
D			E		D
A					A
B	A	D		A	B

B

B	B	A	B	B	B	A	D	A	B	B	B	B	A	B	B		
B	C	<del>F</del> <del>B</del> A	C	B	A				A	B	B	B	C	<del>F</del> <del>B</del> A	C	B	
A	<del>F</del> <del>B</del> A	F	<del>A</del> <del>B</del> F	A	D				E		D	A	<del>F</del> <del>B</del> A	F	<del>A</del> <del>B</del> F	A	
B	C	<del>B</del> <del>A</del> B	C	B	A				A	B	B	B	B	C	<del>B</del> <del>A</del> B	C	B
B	B	A	B	B	B	A	D		A	B	B	B	B	A	B	B	

B

B	A		D	A	B	B	B	A	B	B	B	A	D	A	B
A					A	B	B	A	D	A	B	B	A		A
D			E		D	A			E		D	A		D	
A					A	B	B	A	D		A	B	B	A	
B	A	D		A	B	B	B	A	D		A	B	B	A	B

B

# Final assembly: Crib (hard) and Throw

B

B	A	D	A	B
A				A
D	E		D	
A		D		A
B	A	D		A

B	B	A	B	B
B	C	F	C	B
A	F	F	F	A
B	C	F	C	B
B	B	A	B	B

B	A	D	A	B
A				A
D	E		D	
A		D		A
B	A	D		A

B	B	A	B	B
B	C	F	C	B
A	F	F	F	A
B	C	F	C	B
B	B	A	B	B

B	A	D	A	B
A				A
D	E		D	
A		D		A
B	A	D		A

B	B	A	B	B	B	A	D	A	B	B	B	A	B	B	B	A	D	A	B	B	B	A	B	B		
B	C	F	C	B		A		A	B	C	F	C	B		A		D	E	D	A	B	C	F	C	B	
A	F	F	F	A		D	E	D	A	F	F	F	A		D	E	D	A	F	F	F	A		D	E	D
B	C	F	C	B		A		A	B	C	F	C	B		A		D	E	D	A	B	C	F	C	B	
B	B	A	B	B		A		A	D						A		D									

B	A	D	A	B	B	B	A	B	B	B	A	D	A	B	B	B	A	D	A	B	B	B	A	D	A	B							
A				A	B	C	F	C	B		A		A	B	C	F	C	B		A		D	E	D	A	B							
D	E		D	A	F	F	F	F	A		D	E	D	A	F	F	F	F	A		D	E	D	A	F	F	F	F	A				
A		D		A	B	C	F	C	B		A		A	B	C	F	C	B		A		D	E	D	A	B	C	F	C	B			
B	A	D		A	B	B	A	B	B		A		A	D																			
B	B	A	B	B	B	A	D	A	B	B	B	A	B	B	B	A	D	A	B	B	B	A	B	B	B	A	B	B	B	A	B		
B	C	F	C	B		A		A	B	C	F	C	B		A		D	E	D	A	B	C	F	C	B		A		D	E	D		
A	F	F	F	A		D	E	D	A	F	F	F	A		D	E	D	A	F	F	F	A		D	E	D	A	F	F	F	F	A	
B	C	F	C	B		A		A	B	C	F	C	B		A		D	E	D	A	B	C	F	C	B		A		D	E	D		
B	B	A	B	B		A		A	D						A		D																
B	A	D	A	B	B	B	A	B	B	B	A	D	A	B	B	B	A	D	A	B	B	B	A	D	A	B	B	B	A	B			
A				A	B	C	F	C	B		A		A	B	C	F	C	B		A		D	E	D	A	B	C	F	C	B			
D	E		D	A	F	F	F	F	A		D	E	D	A	F	F	F	F	A		D	E	D	A	F	F	F	F	A		D	E	D
A		D		A	B	C	F	C	B		A		A	B	C	F	C	B		A		D	E	D	A	B	C	F	C	B			
B	A	D		A	B	B	A	B	B		A		A	D																			

B



# Final assembly: Queen

B

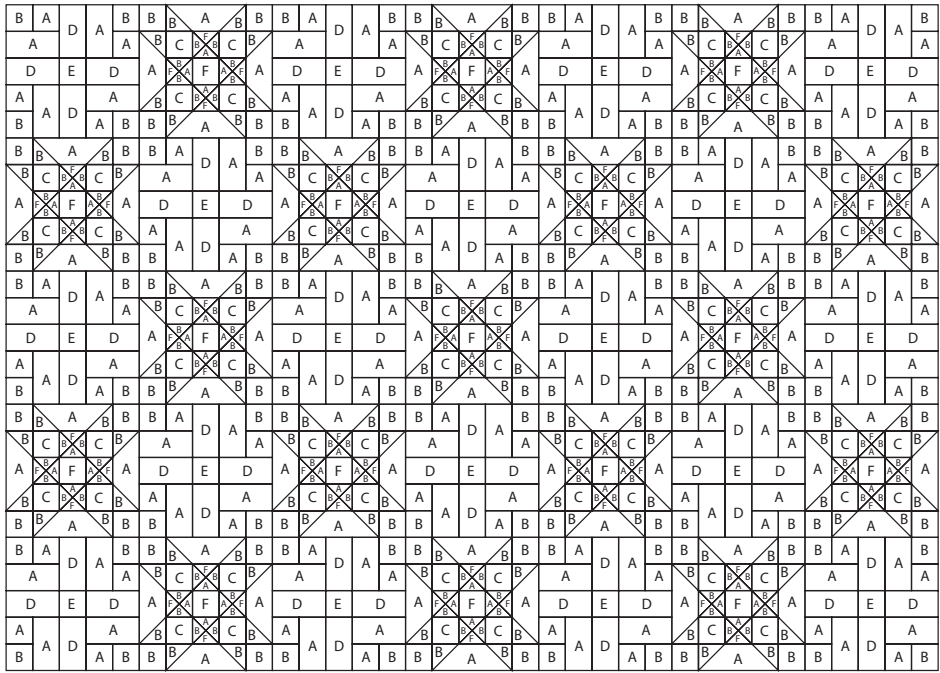
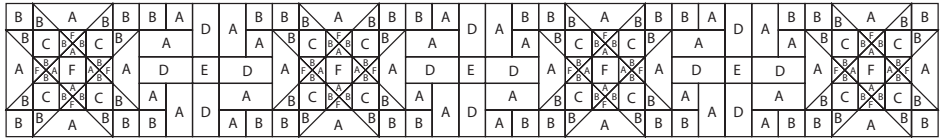
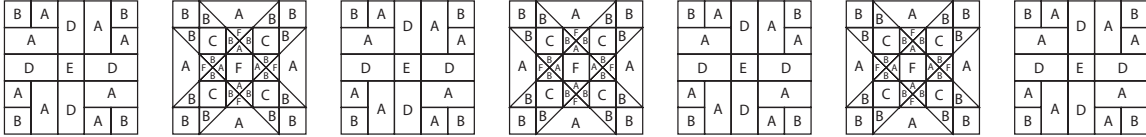

B

# Coloring sheet: Crib (easy)

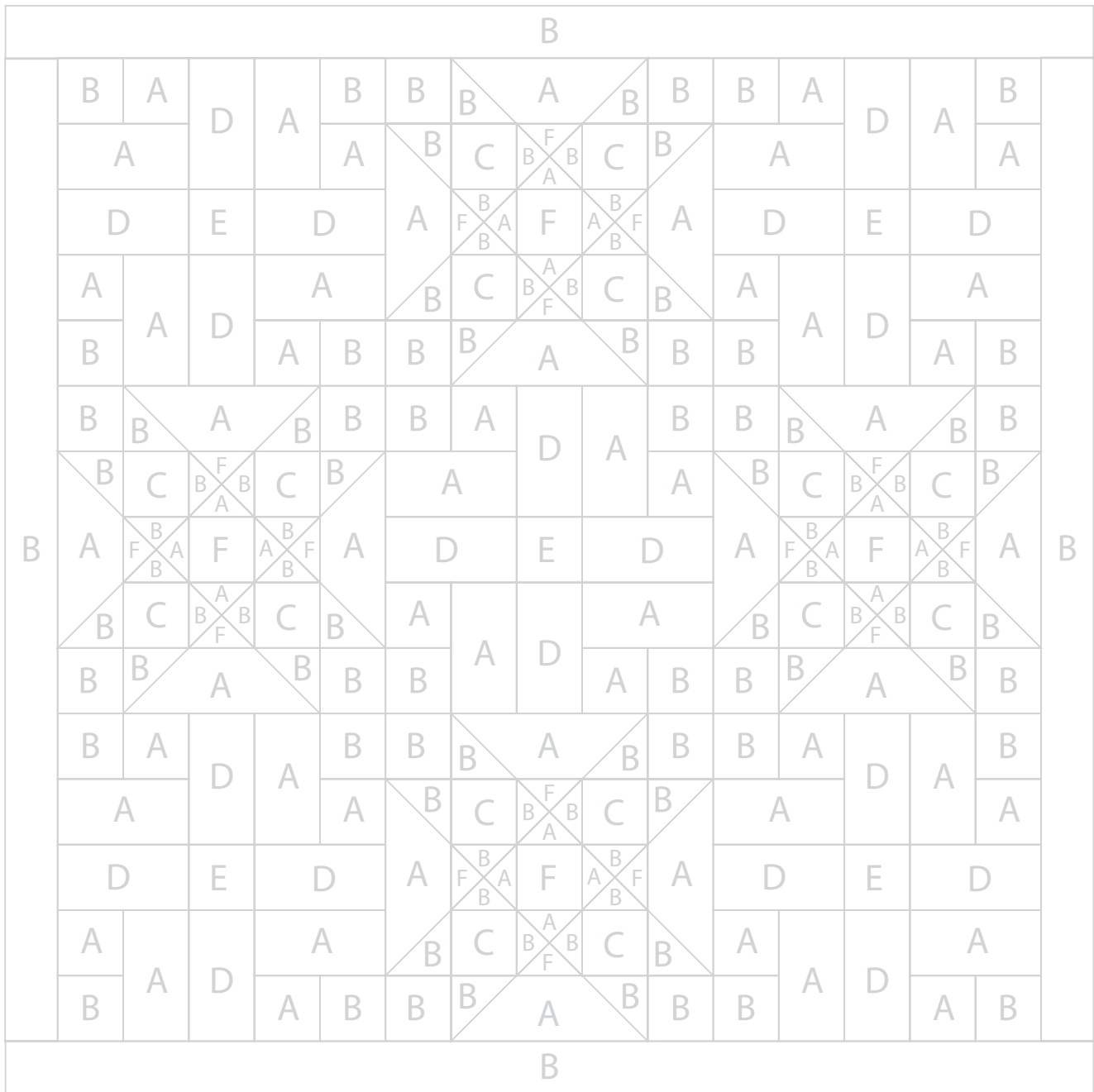



# Coloring sheet: Crib (hard) and Throw

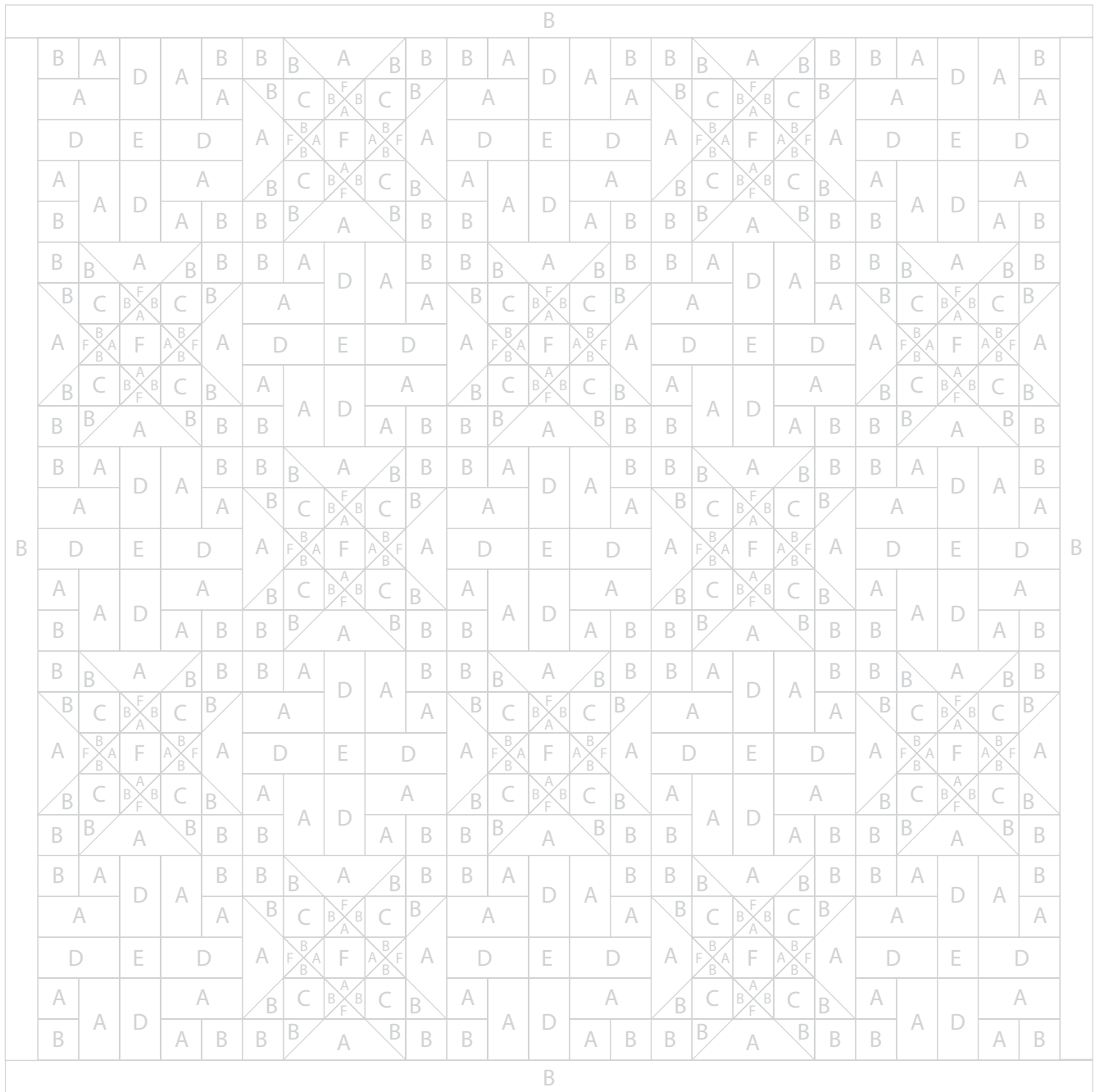

# Coloring sheet: Twin

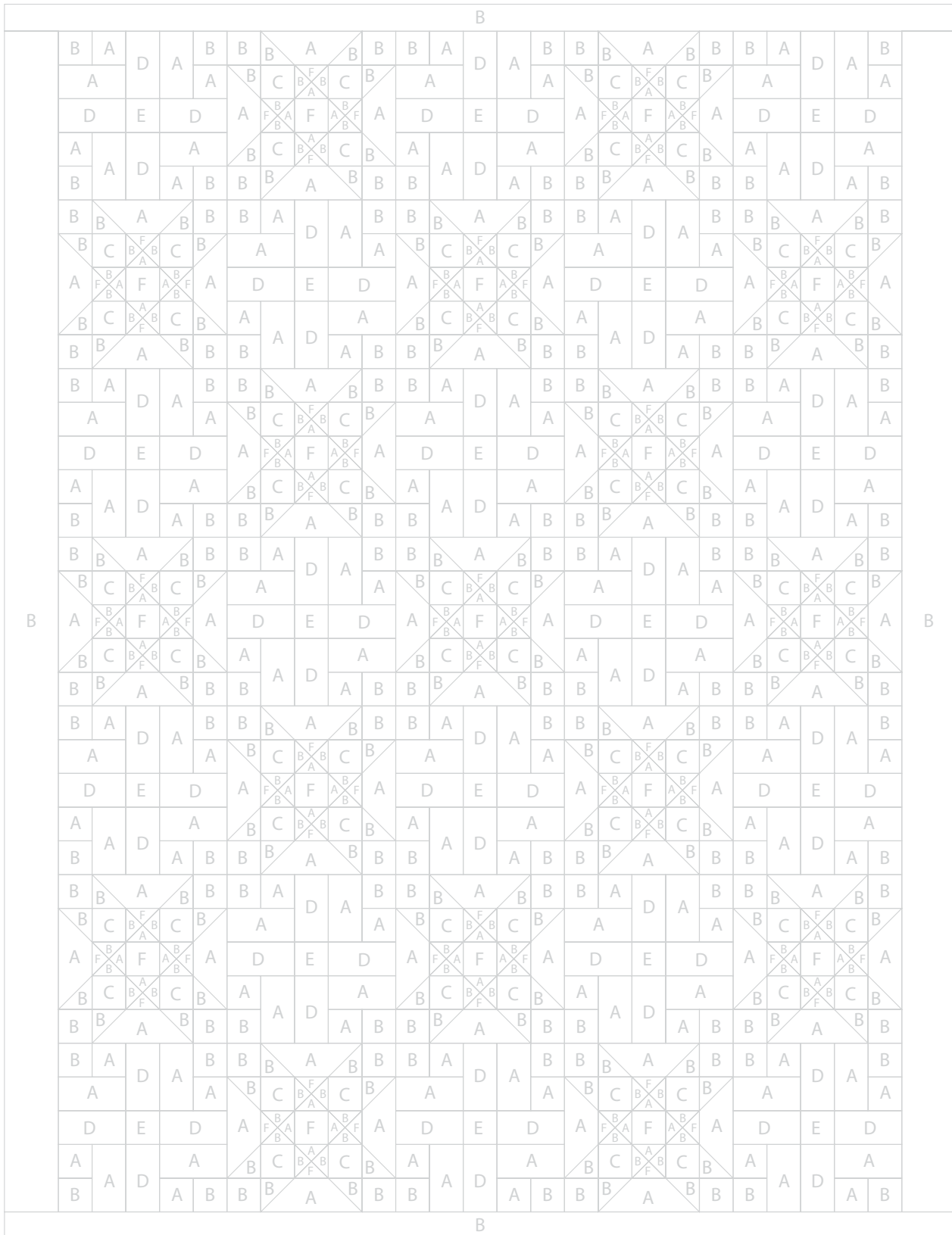

# Coloring sheet: Queen

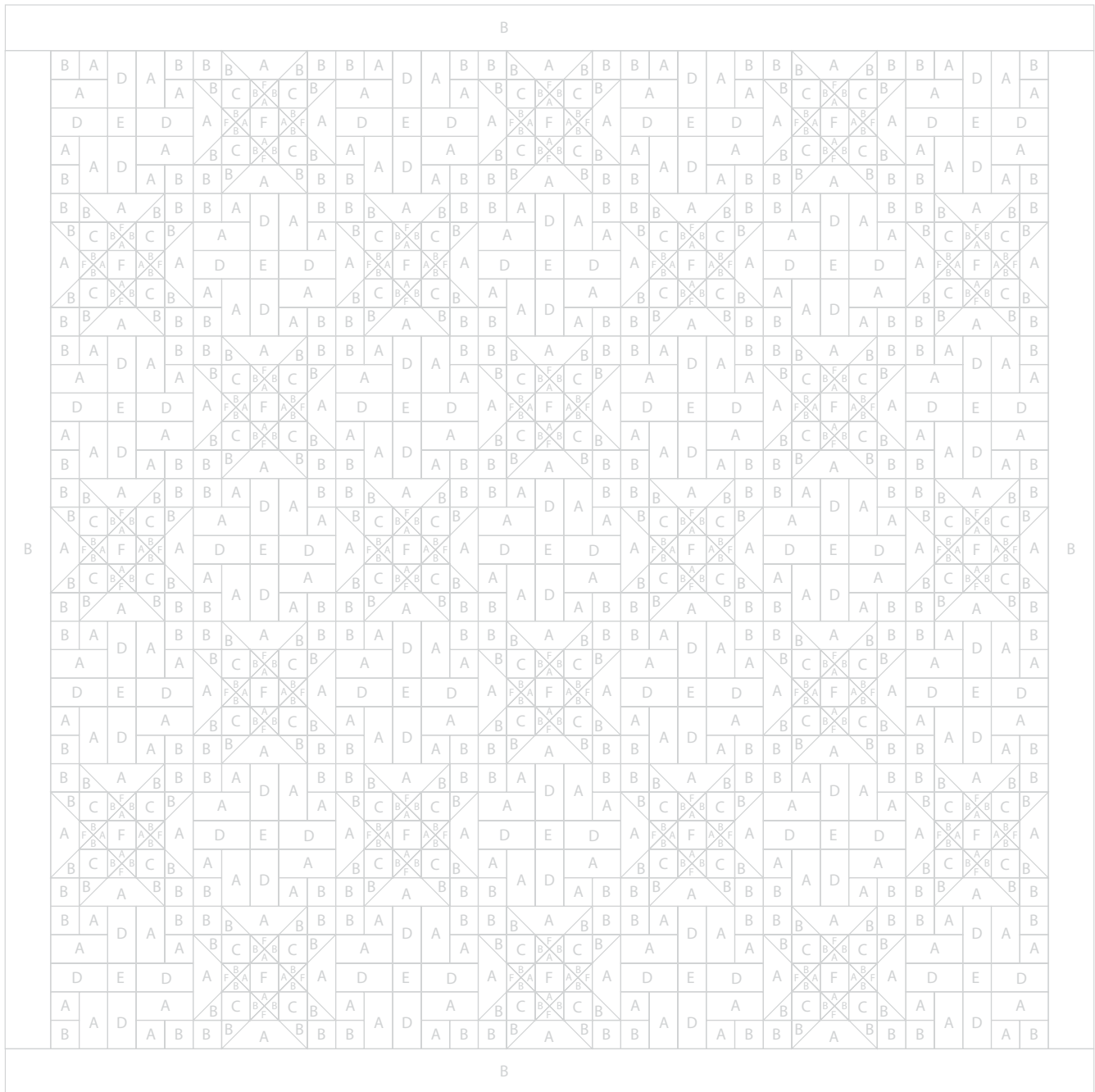

# Cutting diagram: Crib (easy)

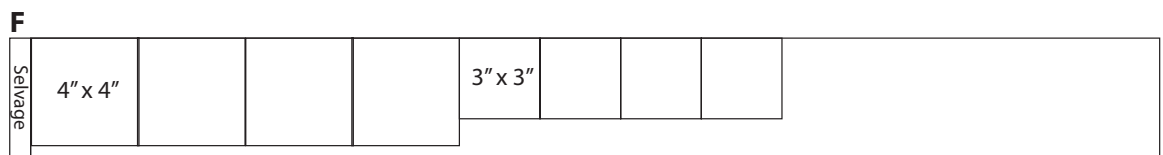
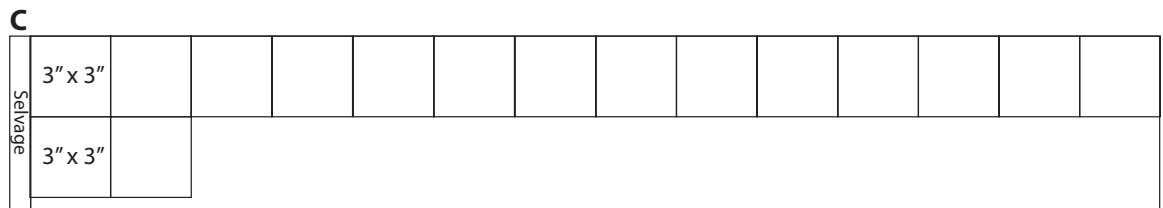
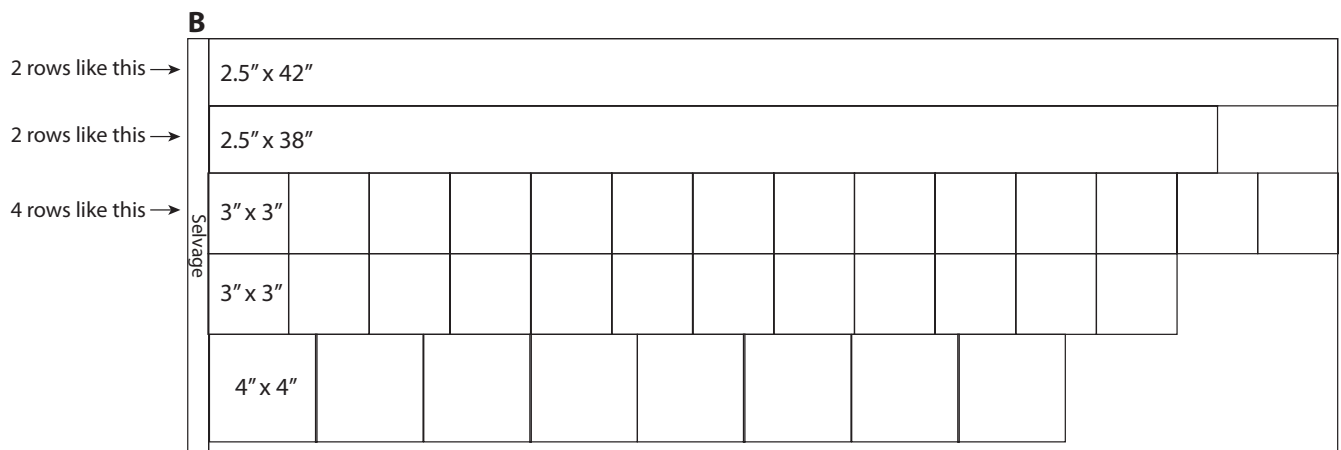
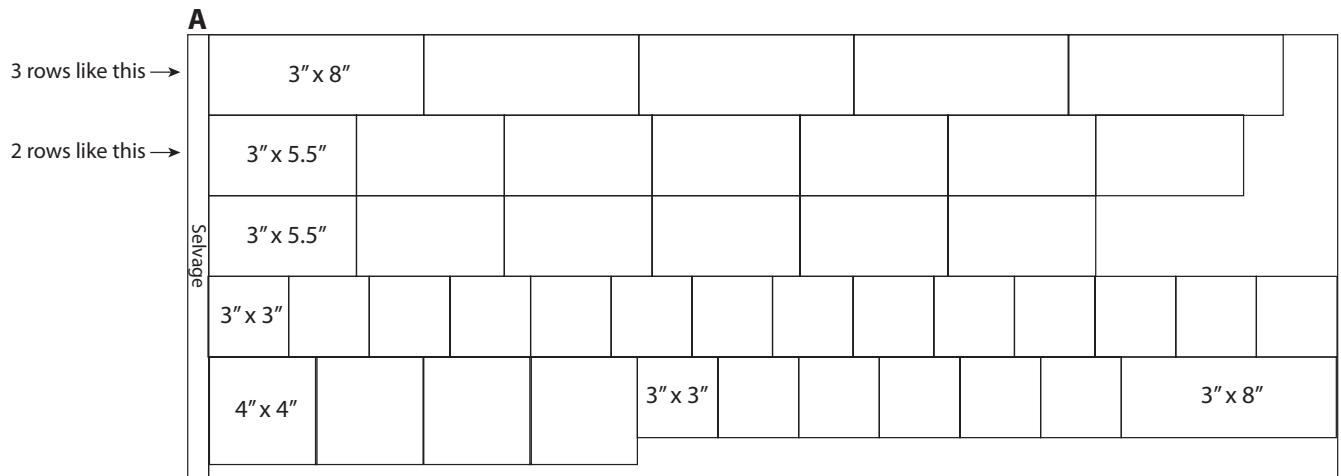

# Cutting diagram: Crib (hard)

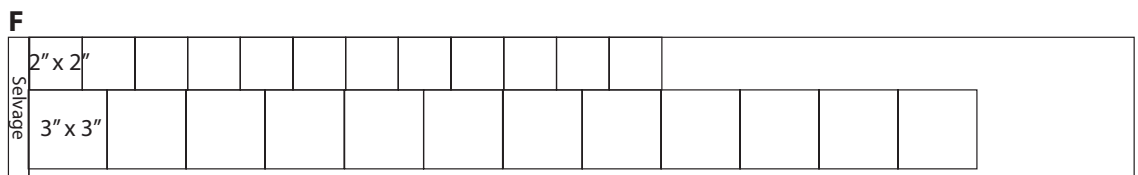
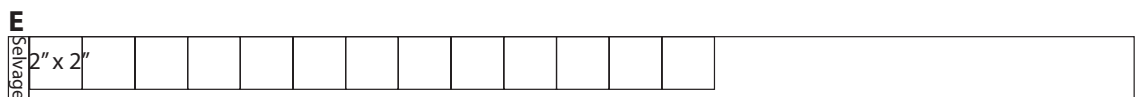
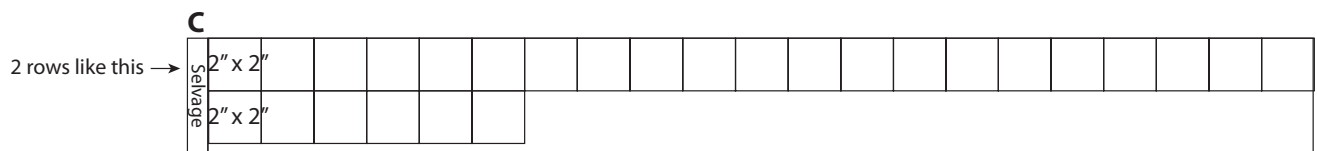
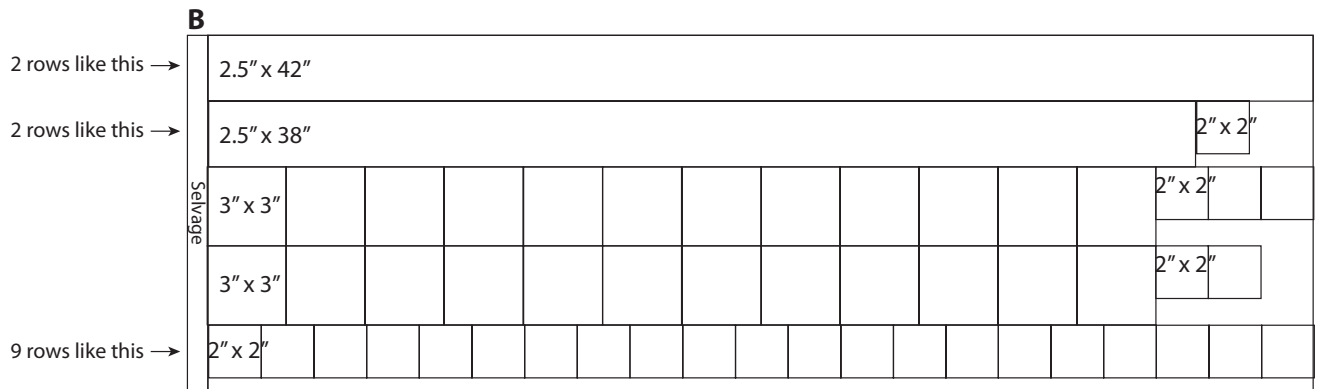
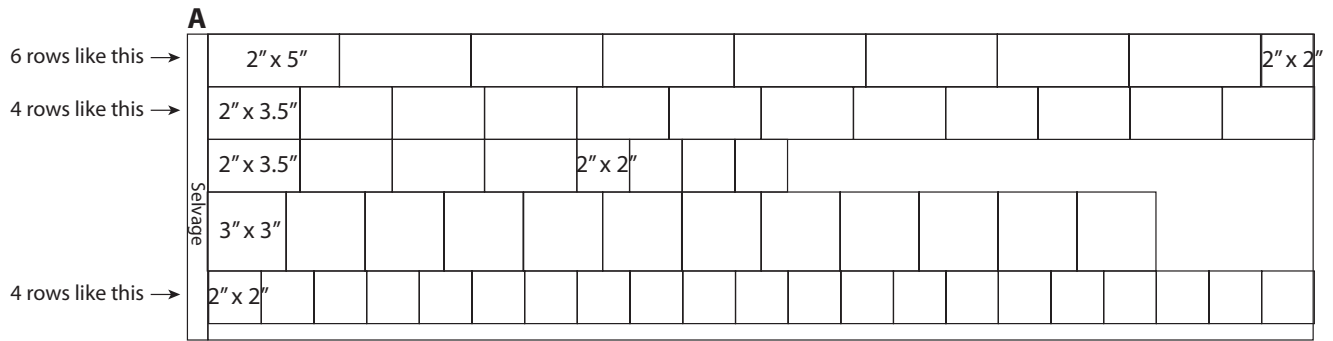



# Cutting diagram: Throw

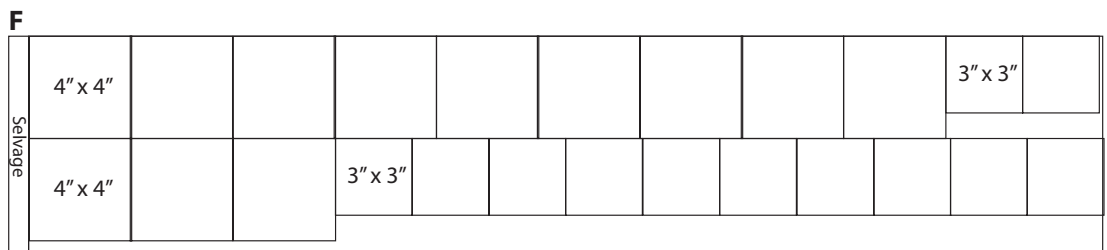
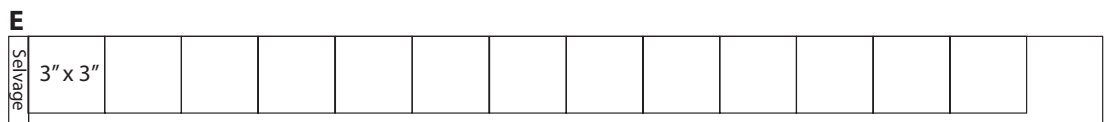
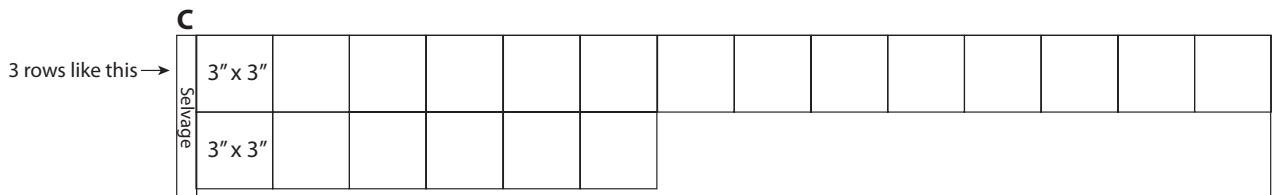
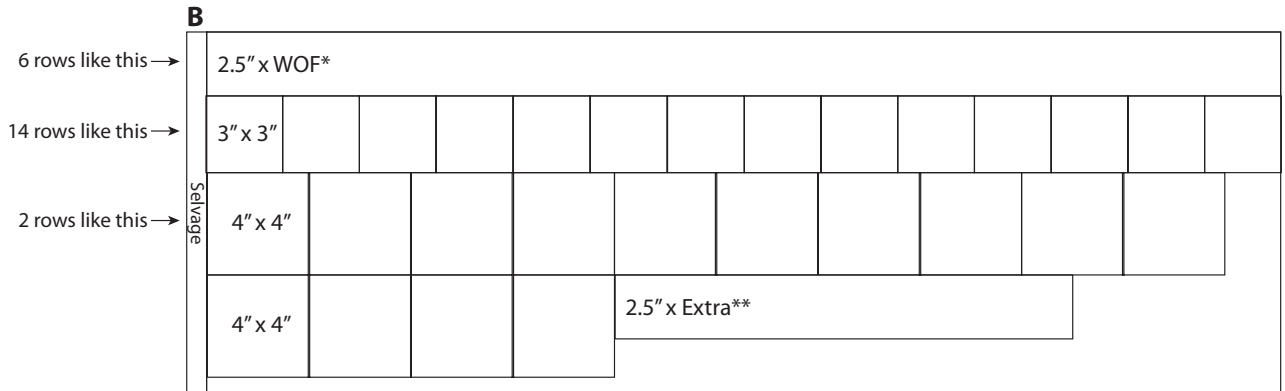
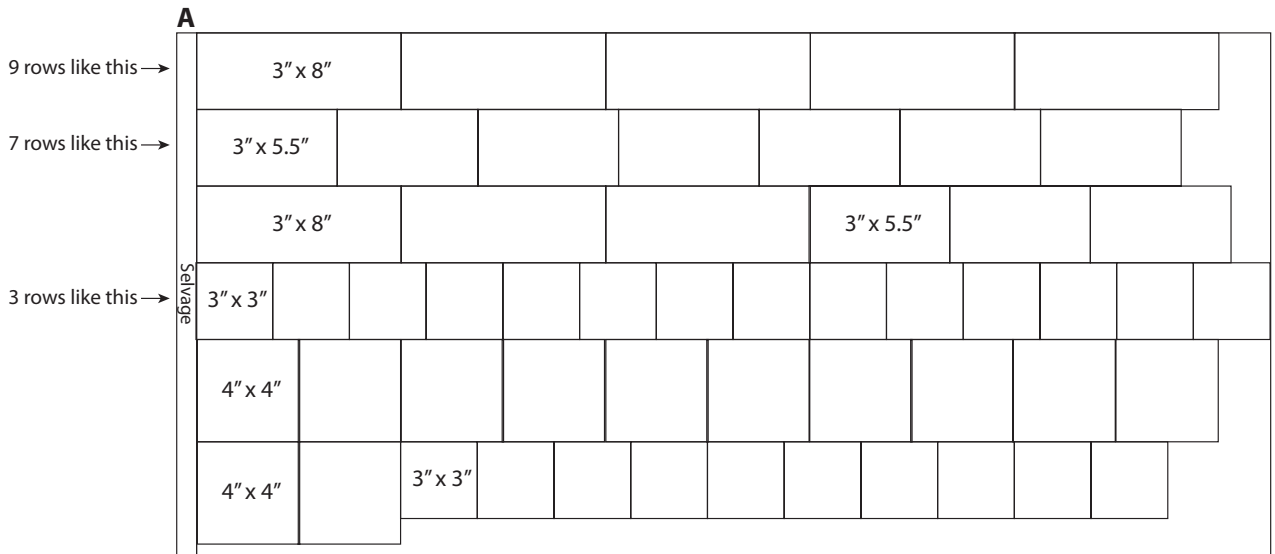

\*WOF = Width of fabric. This means strips cut the full width of your fabric.

\*\*Use this and the extra WOF strips to lengthen two of your WOF strips to 63" and two to 67"

# Cutting diagram: Twin

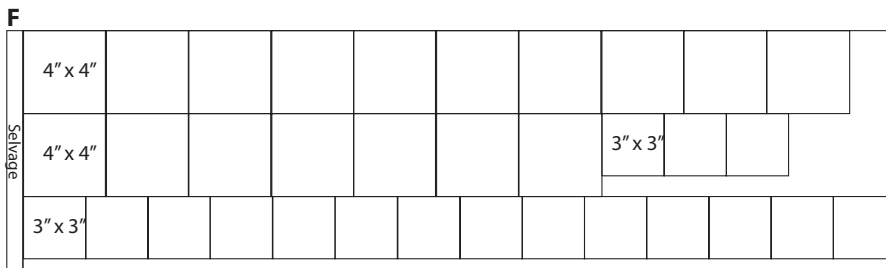
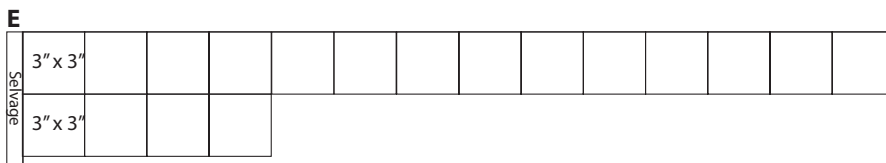
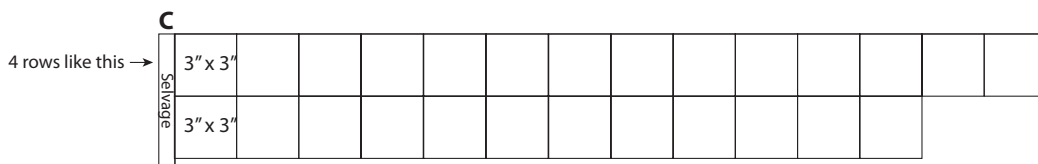
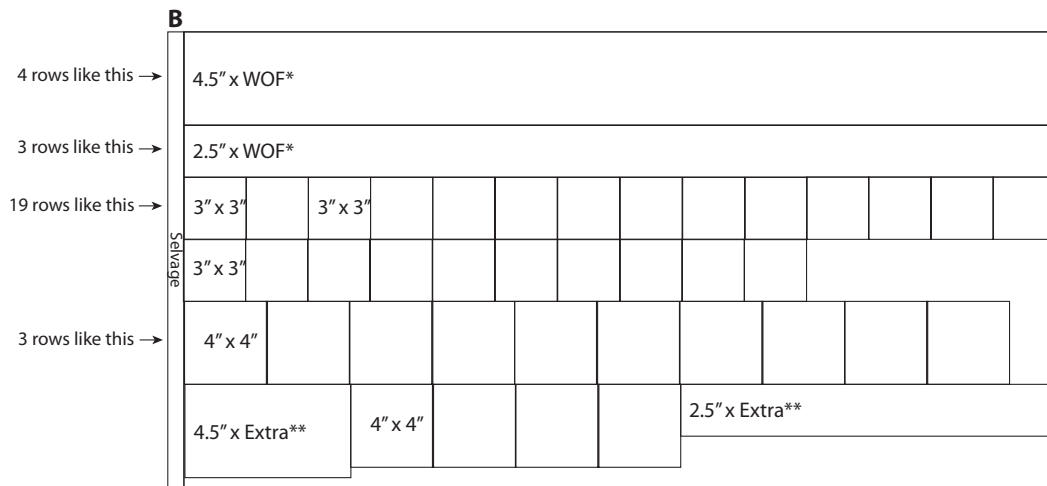
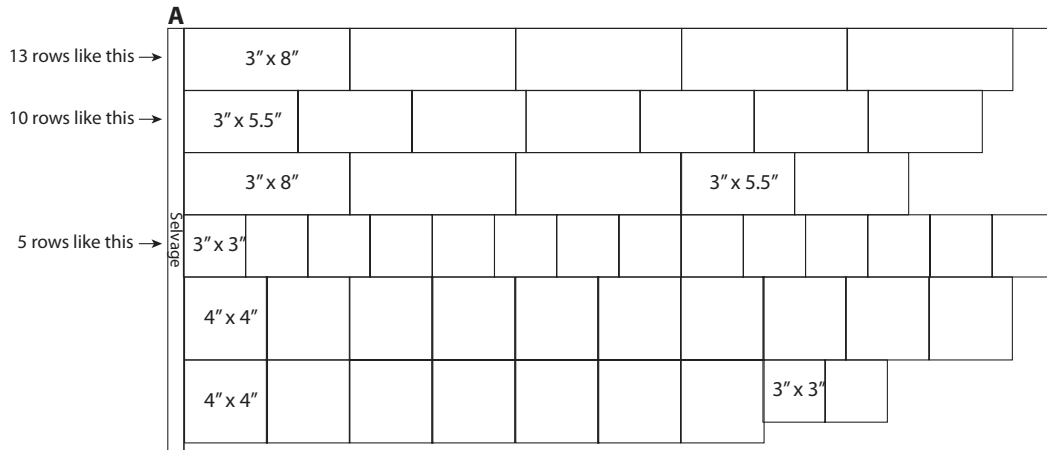

\*WOF = Width of fabric. This means strips cut the full width of your fabric.

\*\*Use this and the extra WOF strips to lengthen two 4.5" x WOF strips to 71" and two 2.5" x WOF strips to 88"

# Cutting diagram: Queen

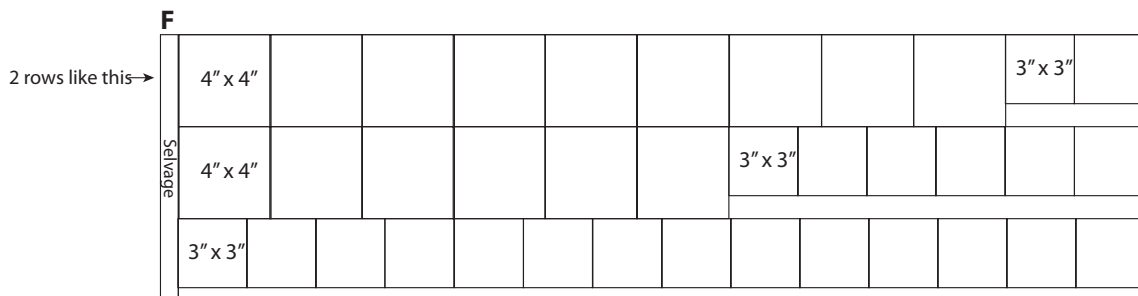
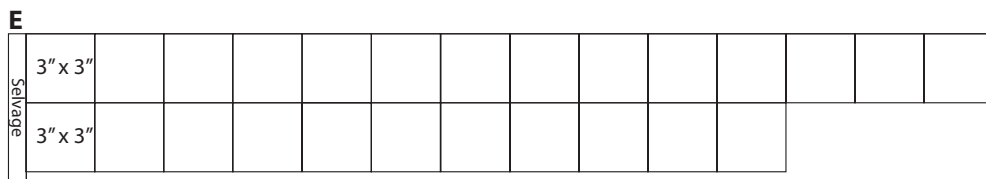
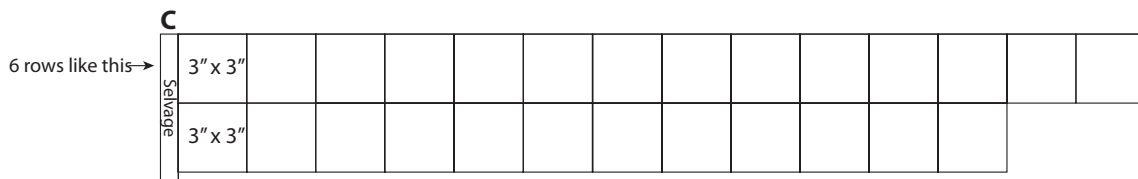
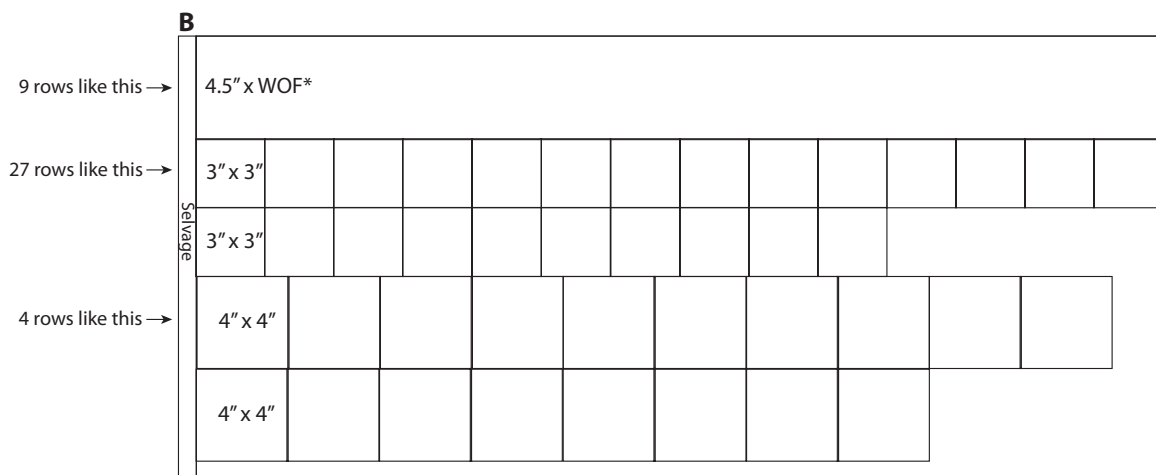
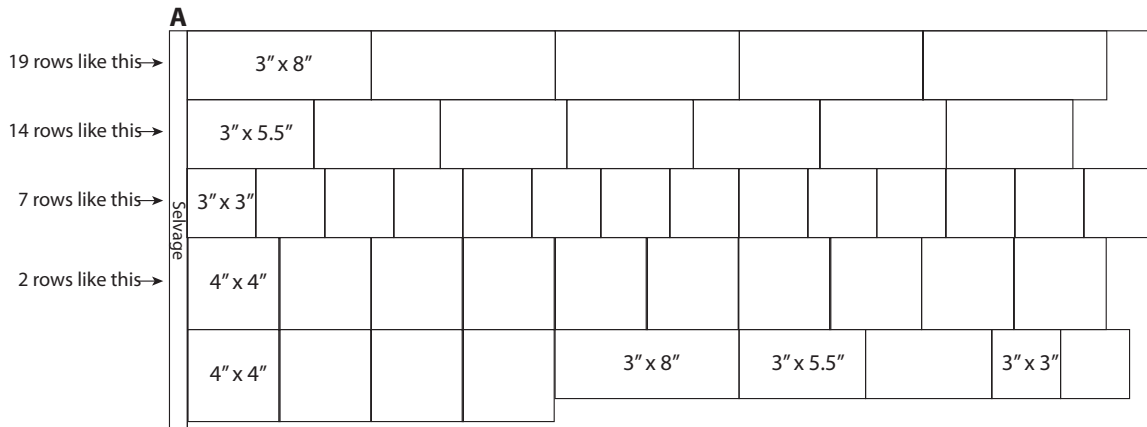

\*WOF = Width of fabric. This means strips cut the full width of your fabric.  
Use the extra WOF strips to lengthen two of your WOF strips to 88" and two to 96"